

Building Radon Out

A Step-by-Step Guide On How To
Build Radon-Resistant Homes

Disclaimer

The U.S. Environmental Protection Agency (EPA) strives to provide accurate, complete, and useful information. However, neither EPA nor any person contributing to the preparation of this document makes any warranty, express or implied, with respect to the usefulness or effectiveness of any information, method, or process disclosed in this material. Nor does EPA assume any liability for the use of, or for damages arising from the use of, any information, method, or process disclosed in this document.

Mention of firms, trade names, or commercial products in this document does not constitute endorsement or recommendation for use.

Acknowledgements

Building Radon Out: A Step-By-Step Guide on How to Build Radon-Resistant Homes was developed by the Indoor Environments Division in the Office of Radiation and Indoor Air at the U.S. Environmental Protection Agency. The lead EPA staff on the document was Paulina Chen. Other staff contributing to the development of this document were: Greg Brunner, Brenda Doroski, Gene Fisher, Matt Hiester, Wendy Kammer, Jennifer Keller, Mike Rogers, and David Rowson.

Much of the description of building techniques in this document is based on training materials prepared by Douglas Kladder of the Center for Environmental Research and Technology, Inc., including the book *Protecting Your Home from Radon* by Kladder, Burkhart, and Jelinek.

Contributions from training sessions of Dave Murane of Sanford Cohen and Associates are also acknowledged.

In addition, EPA would like to gratefully acknowledge the review and contributions of Terry Brennan, Camroden Associates; Robert Brown, International Code Council; Thomas Dickey, City of East Moline, Illinois; Ken Ford, National Association of Home Builders; Douglas Kladder, Western Regional Radon Training Center; and Brad Turk, Mountain West Technical Associates.

Table of Contents



5 Building the Framework: Introduction

6 Does It Make Sense To Build Homes Radon-Resistant?



9 Digging Deeper: Questions and Answers

10 What Is Radon?

11 Is Radon a Significant Health Risk?

12 Is Radon a Problem In Homes?

13 Is There a Safe Level Of Radon?

14 How Does Radon Enter a House?

15 How Does Air Pressure Affect Radon Entry?

16 Does Foundation Type Affect Radon Entry?

17 What Can You Do To Reduce Radon New Homes?

18 What Are The Radon-Resistant Features?

20 Is There a Way To Test The Lot Before Building?

21 Would I Incur Liability By Installing The Features?

22 Should All New Homes Be Built Radon-Resistant?

23 EPA Map of Radon Zones

24 List of Zone 1 Counties



27 Nuts and Bolts: Installation Guide

Planning

- 29 Answer The Question: To Intall Or Not To Install?
- 30 Determine What Type Of System To Install
- 32 Determine Vent Pipe Location And Size

Installation

- 35 Basement and Slab-On-Grade Construction: Sub-Slab Preparation
- 36 Gravel
- 38 Perforated Pipe
- 40 Soil Gas Collection Mat
- 42 Plastic Sheeting
- 43 Seal Off And Label Riser Stub
- 44 Lay Foundation
- 45 Crawlspace Construction
- 51 Seal Openings
- 55 Install Vent Pipe
- 58 Sealing Ducts and Air Handling Units
- 59 Install Electrical Junction Box
- 60 Post-Occupancy Testing
- 62 Activate the System



64 Sold: Working With Homebuyers

- 64 Get An Edge On The Market
- 66 Make a Name For Yourself
- 68 What To Tell Homebuyers

- 72 Appendix A: Architectural Drawings
- 76 Appendix B: Glossary
- 78 Appendix C: For More Information
- 80 Appendix D: State Radon Contacts

Building the Framework: Introduction

Should You Be Concerned About Radon?

Yes.



Radon is a colorless, odorless gas that can cause lung cancer. Your customers rely on you to construct a high quality, safe home. You can easily make a difference in how much radon gets into the homes you build. By using a handful of simple building practices and common materials, you can effectively lower the radon level in the homes that you build, and build most radon problems right out of the house.

Does it make sense to build homes radon-resistant?

Absolutely. There are a number of reasons why you should consider installing radon-resistant features.

You can gain a marketing advantage

Offering homes with radon-resistant features can attract more potential home buyers, which can translate into closing more sales and greater profits. Consumers are becoming more aware that radon is a health risk, and building a home with radon-resistant features could give buyers one more reason to purchase a home from you. About one in every six homes is being built radon-resistant in the United States every year, averaging about 200,000 homes annually, according to annual surveys of home builder practices conducted by the National Association of Home Builders (NAHB) Research Center over the past decade. In high radon areas, about one in every three homes is built with the features.

Industry surveys continue to demonstrate a rapidly growing market for more energy-efficient, environmentally-friendly, comfortable, and healthy homes. Radon-reduction techniques are consistent with state-of-the-art energy-efficient construction. The features can also decrease moisture and other soil gases entering the home, reducing molds, mildews, methane, pesticide gases, volatile organic compounds, and other indoor air quality problems. When using these techniques, follow the Model Energy Code (or other applicable energy codes) for weatherization, which will result in energy savings and lower utility bills for the homeowner.

It is a good investment for a home buyer

It is cheaper to install a radon-reduction system during construction than to go back and fix a radon problem identified later. On average, installing radon-resistant features during construction costs about \$350 - \$500, or even less if you already use some of the techniques for moisture control or energy efficiency. (Many builders who use the techniques have reported actual costs of \$100 or less.) In contrast, retrofitting an existing home will typically cost between \$800 and \$2500.

It is effective

A basic radon reduction system, called a passive sub-slab depressurization system, effectively reduces radon levels by an average of about 50% and, in most cases, to levels below EPA's action level. An upgraded system, called an active sub-slab depressurization system, includes an in-line fan to provide even further reductions.

It is simple to install

All of the techniques and materials are commonly used in construction. No special skills or materials are required.

Upgrading is easy

After occupancy, all homes should be tested for radon, even those built with radon-resistant features. EPA recommends that homes with radon levels at or above 4 picocuries per liter of air (pCi/L) be fixed. Homes with a passive system can be upgraded to an active system with the simple installation of a special in-line fan to further reduce the radon level. Typically, the passive system includes a junction box in the attic to make the future installation of the fan easy. This upgrade is also used by some builders to control moisture in basements and crawlspaces.

Digging Deeper: Questions and Answers

This chapter digs deeper into some of the more commonly asked questions concerning radon-resistant new construction.



What Is Radon?

Radon is a radioactive gas. It comes from uranium and radium in soils, which can be found everywhere in the world. Uranium is present in rocks such as granite, shale, phosphate and pitchblende. Uranium breaks down to radium, which then decays into radon. This gas can easily move up through the soil into the atmosphere. Natural deposits of uranium and radium, not man-made sources, produce most of the radon present in the air.

Radon is in the soil and air everywhere in varying amounts.

People cannot see, taste, feel, or smell radon. There is no way to sense the presence of radon.

Radon levels are commonly expressed in picocuries per liter of air (pCi/L), where a picocurie is a measure of radioactivity.

The national average of indoor radon levels in homes is about 1.3 pCi/L. Radon levels outdoors, where radon is diluted, average about 0.4 pCi/L.

Radon in the soil can be drawn into a building and can accumulate to high levels. Every building or home has the potential for elevated levels of radon. All homes should be tested for radon, even those built with radon-resistant features. EPA recommends taking action to reduce indoor radon levels when levels are 4 pCi/L or higher.



Is Radon A Significant Health Risk?

When radon enters a home, it decays into radioactive particles that have a static charge, which attracts them to particles in the air. These particles can get trapped in your lungs when you breathe. As the radioactive particles break down further, they release bursts of energy which can damage the DNA in lung tissue. In some cases, if the lung tissue does not repair the DNA correctly, the damage can lead to lung cancer.

Not everyone exposed to elevated levels of radon will develop lung cancer, but your risk of getting radon-induced lung cancer increases as your exposure to radon increases (either because the radon levels are higher or you live in the home longer). Smokers who have high radon levels in their homes are at an especially high risk for getting radon-induced lung cancer.

The evidence that radon causes lung cancer is extensive and based on: human data taken from studies of underground miners carried out over more than 50 years in five countries, including the United States and Canada; human data from studies in homes in many different nations, including the U.S. and Canada; and biological and molecular studies.

Radon is classified as a Class A carcinogen (known to cause cancer in humans).

Some other Class A carcinogens are arsenic, asbestos, and benzene.

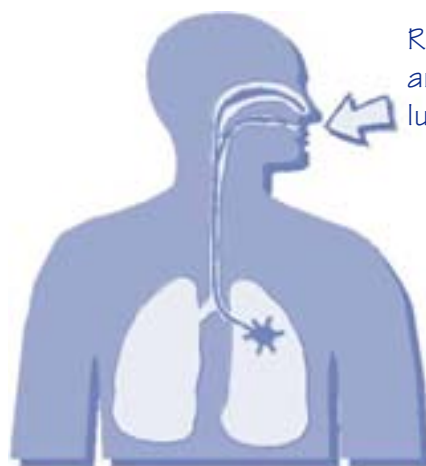

Radon decay particles are breathed into the lungs

Energy released from radon decay products damages DNA



Is Radon A Health Problem In Homes?

Radon is the second leading cause of lung cancer in the United States.

Radon causes about 20,000 lung cancer deaths per year.

The following is a sample of organizations which state that radon is a health threat in homes:

- ✓ U.S. Surgeon General
- ✓ American Medical Association
- ✓ American Lung Association
- ✓ Centers for Disease Control
- ✓ National Cancer Institute
- ✓ National Academy of Sciences
- ✓ Environmental Protection Agency

The risk of developing lung cancer from radon has been clearly demonstrated in underground miners. Did you know that the average lifetime radon exposure for the general population is about the same as the levels of exposure at which increased risk has been demonstrated in underground miners?

A study released by the National Academy of Sciences on February 19, 1998 called "The Health Effects of Exposure to Indoor Radon" is the most definitive accumulation of scientific data on indoor radon. The report concludes that radon causes 15,000 - 22,000 deaths per year, making it the second leading cause of lung cancer in the U.S. and a serious public health concern.

Have You Heard Of Stanley Watras?

Stanley J. Watras was a construction engineer at the Limerick nuclear power plant in Pottstown, Pennsylvania. One day, on his way to work, he entered the plant and set off the radiation monitor alarms which help protect workers by detecting exposure to radiation. Safety personnel checked him out, but could not find the source of the radiation. Interestingly, because the plant was under construction at the time, there was no nuclear fuel at the plant. They discovered the source of radiation exposure when Watras's home was tested and was measured to have very high radon levels (2,700 pCi/L). After installing a radon-reduction system, radon levels in the home tested below 4 pCi/L.

Is There A Safe Level Of Radon?

There is no known safe level of radon. As your exposure to radon is increased, so is your risk for developing lung cancer. Even radon levels below 4pCi/L pose some risk.

Homes have been found with radon levels above 20, 100, and in rare cases even 2000 pCi/L. High indoor radon levels have been found in every state.

EPA, the Surgeon General, the Centers for Disease Control, and many other health organizations recommend that action be taken to reduce indoor radon levels at or above 4.0 pCi/L, which is a reasonably achievable level of radon in homes using currently available cost-effective techniques.

Radon is a significant risk. More people die from lung cancer caused by radon each year than from many other highly publicized causes of death.

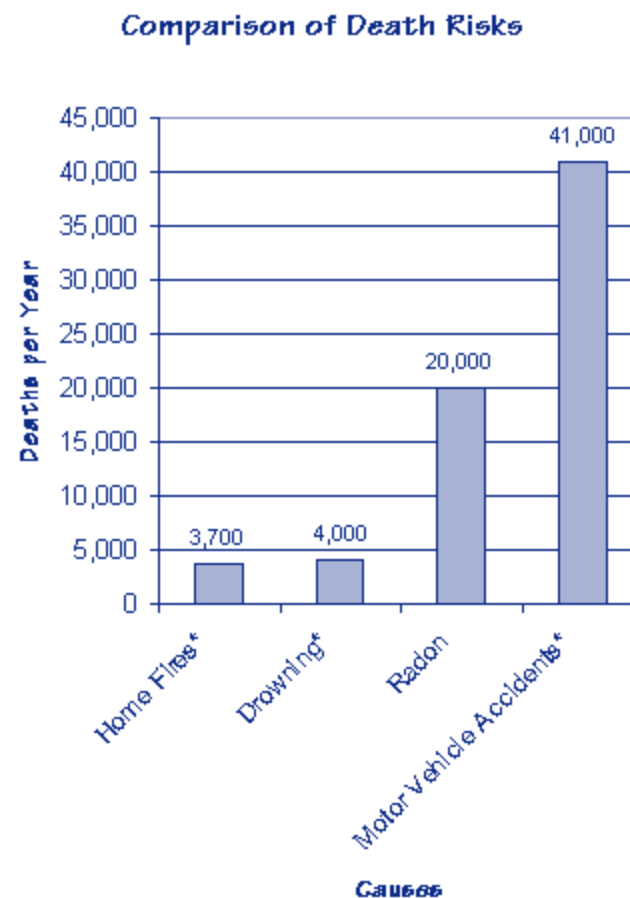

* data from the National Safety Council, 1999

How Does Radon Enter A House?

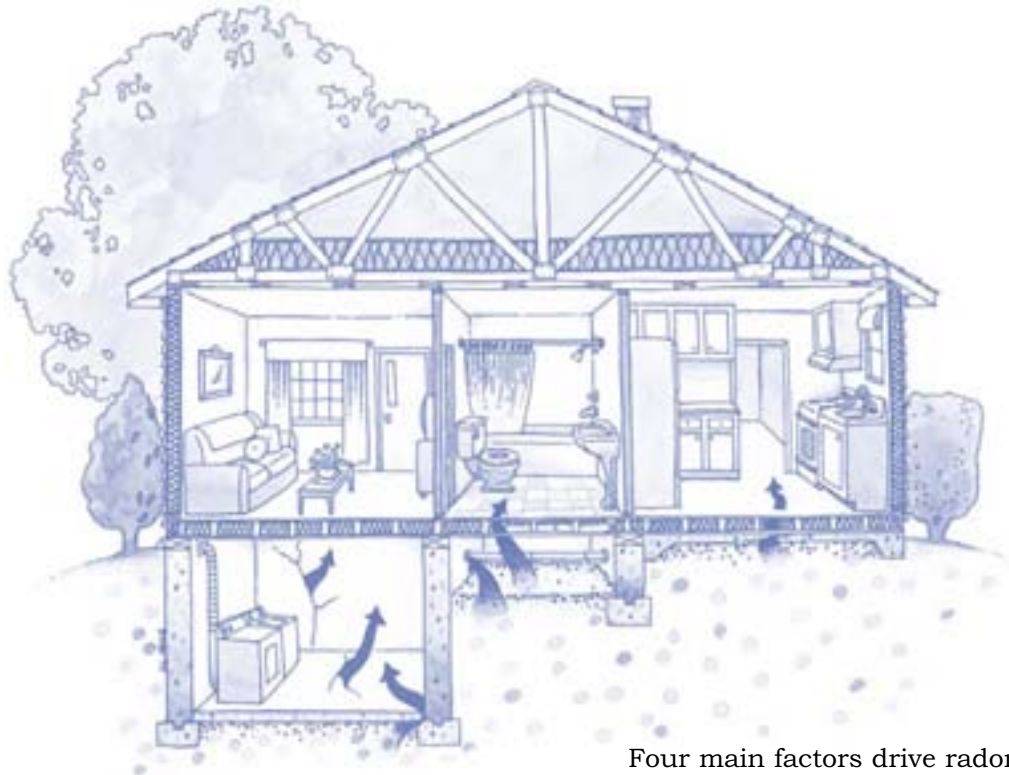

Common Radon Entry Points

Four main factors drive radon entry into homes. All of these factors exist in most homes throughout the country.

1. Uranium is present in the soil nearly everywhere in the United States.
2. The soil is permeable enough to allow radon to migrate into the home through the slab, basement or crawlspace.

3. There are pathways for the radon to enter the basement, such as small holes, cracks, plumbing penetrations, or sumps. All homes have radon entry pathways.

4. An air pressure difference between the basement or crawlspace and the surrounding soil draws radon into the home.

How Does Air Pressure Affect Radon Entry?

The air pressure in a house is generally lower than in the surrounding air and soil, particularly in the basement and foundation levels. This difference in pressure causes a house to act like a vacuum, drawing air containing radon and other soil gases in through foundation cracks and other openings. Some of the replacement air comes from the underlying soil and can contain radon.

One reason why this pressure difference occurs is because exhaust fans remove air from inside the house. When this air is exhausted, outside air enters the house to replace it. Another cause for a pressure difference is that warm air rises and will leak from openings in the upper portion of the house when temperatures are higher indoors than outdoors. This condition, known as “stack effect,” causes unconditioned replacement air to enter the lower portion of the house.

Mechanical systems, such as the furnaces or central air conditioners, may also contribute to the difference in air pressure. In areas with very short mild winters, mechanical systems can

be the dominant driving force. Air handlers and leaky return ducts can not only draw in radon, they can also distribute it throughout a home.

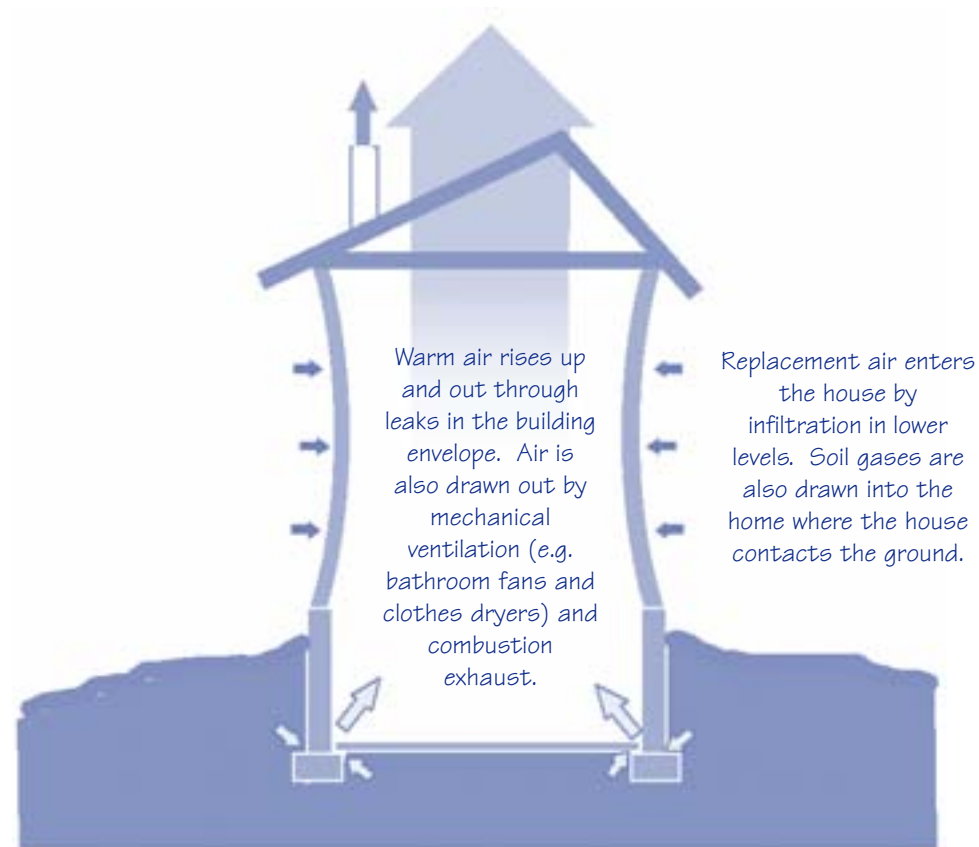

Does Foundation Type Affect Radon Entry?

Because radon can literally be sucked into a home, any home can potentially have a radon problem. All conventional house construction types have been found to have radon levels exceeding the action level of 4 pCi/L.

Basement



Radon can enter through floor-to-wall joints and control joints and cracks in the slab.

Slab-On-Grade



Radon can enter a home regardless of whether or not there is a basement. Slabs built on grade can have just as many openings to allow radon to enter as do basements.

Crawlspace



The vacuums that exist within a home are exerted on the crawlspaces causing radon and other gases to enter the home from the earthen area below. Even with crawlspace vents, a slight vacuum is still exerted on the crawlspace. Measurements in homes with crawlspaces have shown elevated radon levels.

Manufactured Homes



Unless these buildings are set up on piers without any skirting placed around them, interior vacuums can cause radon to enter these types of homes as well.

What Can You Do To Reduce Radon In New Homes?

You can easily draw radon away and help prevent radon from entering the home by with the following basic steps.

You may already be employing many of these techniques in the homes that you build. All of the techniques have additional benefits associated with them and they are very easy to install.

Install a sub-slab (or sub-membrane) depressurization system

The objective of these systems is to create a vacuum beneath the foundation which is greater in strength than the vacuum applied to the soil by the house itself. The soil gases that are collected beneath the home are piped to a safe location to be vented directly outside.

Use mechanical barriers to soil gas entry

Plastic sheeting and foundation sealing and caulking can serve as barriers to radon entry, entry of other soil gases, and moisture.

Reduce stack effect

Sealing and caulking reduce stack effect, and thus reduce the negative pressure in lower levels in the home.

Install air distribution systems so that soil air is not “mined”

Air-handling units and all ducts in basements and, especially, in crawlspaces should be sealed to prevent air, and radon, from being drawn into the system. Seamless ducts are preferred for runs through crawlspaces or beneath slabs. Any seams or joints in ducts should be sealed.

Can we keep radon out by sealing the cracks?

Sealing large cracks and openings is important to do when you build a home, both in the lower portion of the home to reduce radon entry points, and in the upper portion of the home to reduce stack effect. However, field research has shown that attempting to seal all of the openings in a foundation is both impractical and ineffective as a stand-alone technique. Radon can enter through very small cracks and openings. These small cracks and openings are too small to locate and effectively seal. Even if all cracks could be sealed during construction, which would be costly, building settlement may cause new cracks to occur. Therefore, sealing large cracks and openings is one of the key components of radon-resistant construction, but not the only technique that should be employed.

What Are The Radon-Resistant Features?

The techniques may vary for different foundations and site requirements, but the basic elements of the passive sub-slab depressurization system are shown on the opposite page.

In many parts of the country, the gravel beneath the slab (gas-permeable layer), plastic sheeting, and sealing and caulking are already employed for moisture reduction. In these cases, simply adding the vent pipe and junction box is extremely cost-effective for reducing radon, and so cost-effective that even a cost-conscious builder like Habitat for Humanity has been adding these features in many of its homes.

There are more in-depth discussions about installing the features in the next chapter.

What pulls the soil gas through the pipe?

If the pipe is routed through warm space (such as an interior wall or the furnace flue chase, following local fire codes), the stack effect can create a natural draft in the pipe. Because this method requires no mechanical devices, it is called a *passive soil depressurization system*.

If further reduction is necessary to bring radon levels in a home below the action level of 4 pCi/L or even lower, an in-line fan can be installed in the pipe to activate the system. The system is then called an *active soil depressurization system*. The future installation of the fan can be made easier with a little planning during

A. Gas Permeable Layer

Usually a 4-inch layer of clean, coarse gravel is used beneath the slab to allow the soil gas to move freely underneath the house. Other options are to install a loop of perforated pipe or soil gas collection mat (also known as drainage mat or soil gas matting).

B. Plastic Sheetting

Polyethylene sheeting is placed on top of the gas permeable layer to help prevent the soil gas from entering the home. The sheeting also keeps concrete from clogging the gas permeable layer when the slab is poured.

C. Vent Pipe

A 3- or 4-inch (recommended) PVC or other gas-tight pipe (commonly used for plumbing) runs from the gas permeable layer through the house and roof to safely vent radon and other soil gases above the house. Although some builders have used 3-inch pipe, field results have indicated that passive systems tend to function better with 4-inch pipe.

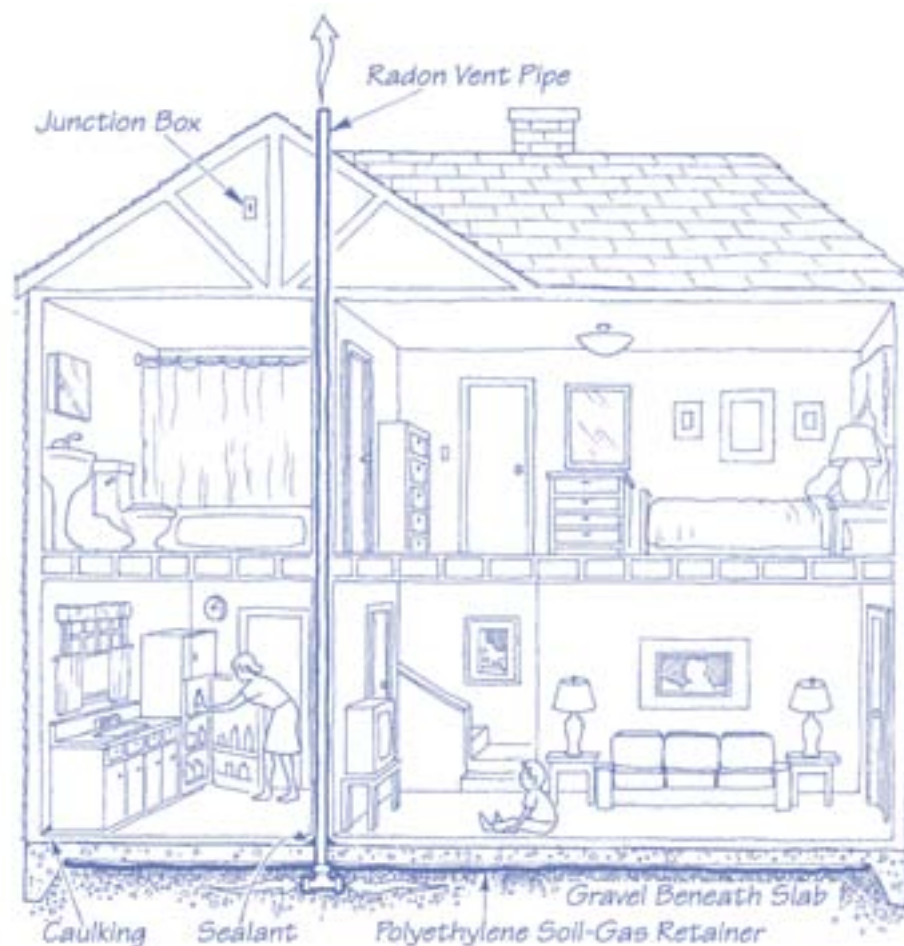

D. Junction Box

An electrical junction box is wired in case an electric venting fan is needed later to activate the system.

E. Sealing and Caulking

All openings in the concrete foundation floor are sealed to prevent soil gas from entering the home. Also, sealing and caulking the rest of the building envelope reduces stack effect in the home.

Is There A Way To Test The Lot Before Building?

Soil testing for radon is not recommended for determining whether a house should be built radon-resistant. Although soil testing can be done, it cannot rule out the possibility that radon could be a problem in the house you build on that lot. Even if soil testing reveals low levels of radon gas in the soil, the amount of radon that may enter the finished house cannot be accurately predicted because one cannot predict the impact that the site preparation will have on introducing new radon pathways or the extent to which a vacuum will be produced by the house. Furthermore, the cost of a single soil test for radon ranges from \$70 to \$150, and *at least* 4 to 8 tests could be required to accurately characterize the radon in the soil at a single building site. Therefore, the cost to perform soil testing is very high when compared with installing the passive radon system in high radon potential areas (see page 22 on high radon potential areas).

Why not wait to install the features until after the home is completed and a radon test is performed?

It is much easier and far less costly to prepare the sub-grade to improve soil gas flow before the slab is cast. Also, the pipe itself can be run more easily through the house before it is finished. This significantly improves aesthetics and can reduce subsequent system

operating costs by planning to route the pipe through warm space to maximize passive operation of the system.

The best way to determine the radon level in a home: ***test the home for radon after occupancy.***



Would I Incur Liability By Installing The Features?

New homes built in the United States are not required to meet a specified radon level. You are not required to test a home, nor to guarantee that a home will meet a specified radon level. By installing radon-resistant features, you are proactively offering your home buyers features designed to reduce radon levels. Adopting radon-resistant building techniques should not increase your liability risks in any jurisdiction as long as due care is exercised in following the proper construction techniques. Especially in high radon areas, radon-resistant features may actually help you market and sell the homes you build.

Once you have decided to build radon-resistant, you will want to make sure to install the features properly. If your building code includes provisions for the radon features, follow your code requirements. Otherwise, follow the guidance provided in this document or in any of the following documents:

- *Model Standards and Techniques for Control of Radon in New Residential Buildings*, EPA, March 1994
- Appendix F: *One and Two-Family Dwelling Code*, 1995 Edition, Council of American Building Officials
- Appendix D: *International One and Two-Family Dwelling Code*, 1998 Edition, International Code Council
- Appendix F: *International Residential Code*, 2000 Edition, International Code Council
- *Standard Guide for Radon Control Options for the Design and Construction of New Low Rise Residential Buildings*, E 1465-92, American Society for Testing and Materials

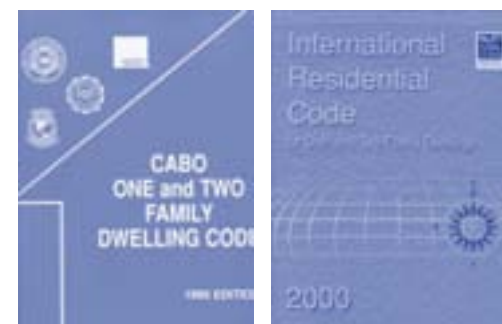

Should All New Homes Be Built Radon-Resistant?

All homes could benefit from having a radon reduction system. However, it is especially cost effective to install the features in homes with the greatest potential for high radon levels.

The potential for elevated radon levels is not uniform throughout the United States. EPA and the U.S. Geological Survey have identified areas of the country with the greatest potential for high radon levels. The map shown on the next page is the result of indoor radon measurements, local geology, and population densities in a combined effort to rank radon potentials in all counties across the U.S. The map indicates three radon potential zones defined by the likelihood of finding radon measurements within certain ranges when a short-term closed building radon test is performed.

EPA recommends that all homes built in Zone 1 (high radon potential) areas have radon reduction systems.

NAHB also recommends using the passive system in homes in high radon potential areas (Zone 1). Zone 1 counties are listed by state on pages 24 and 25.

If you are building in a Zone 2 or 3 area, the homes you build could still have high radon levels, particularly if there is a radon “hot spot” in your county. According to an annual survey by the NAHB Research Center, about 60,000 homes in Zone 2 and 3 are built with radon-resistant techniques each year. You may want to consider applying the techniques in these areas too. Since the map was developed, many States have acquired additional information on high radon areas. Contact your state radon office for more information.

Consumers have asked for the radon-reduction features in many different parts of the country and in all three radon zones.

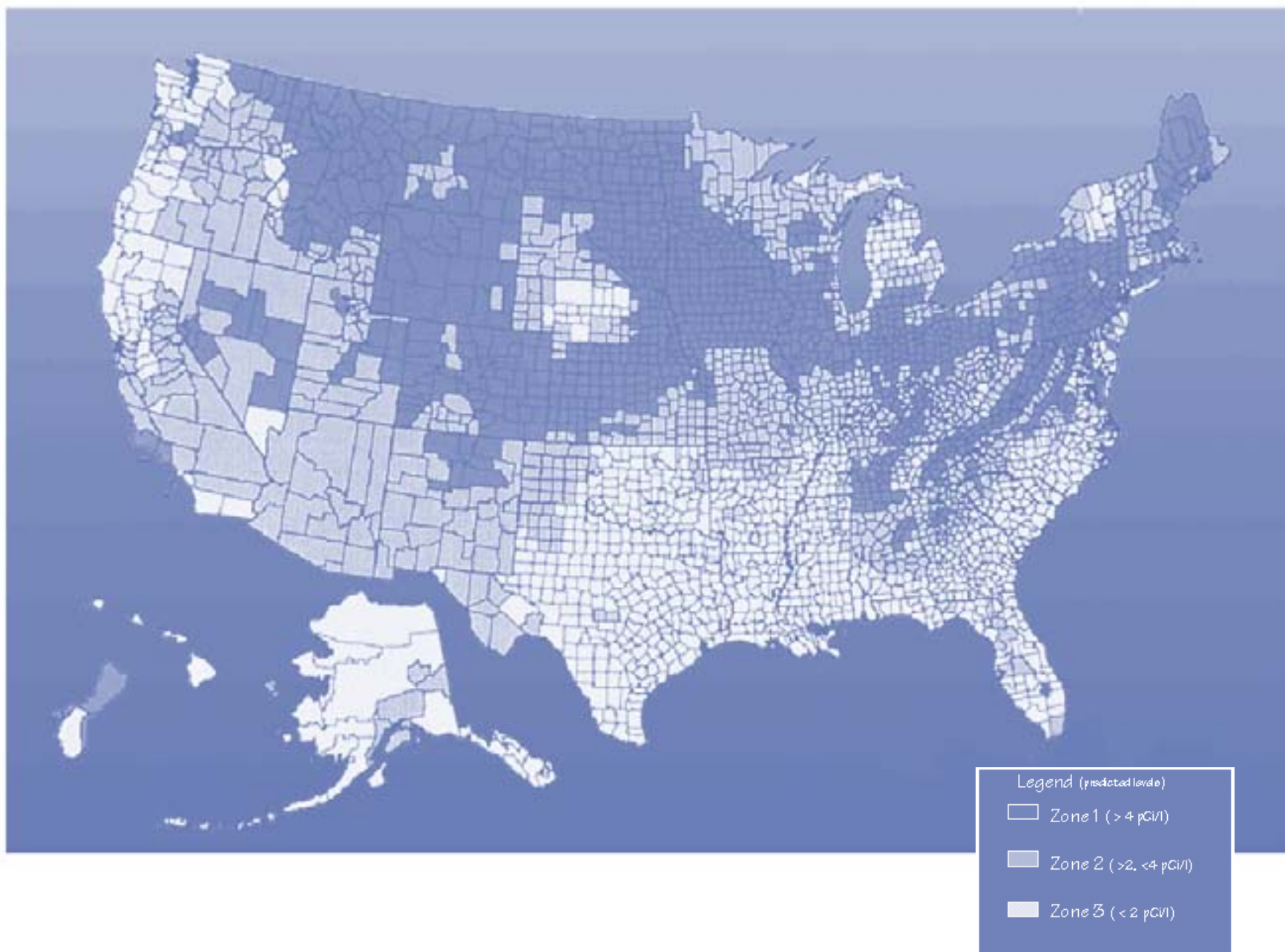

List of Zone 1 Counties

ALABAMA

Calhoun
Clay
Cleburne
Colbert
Coosa
Franklin
Jackson
Lauderdale
Lawrence
Limestone
Madison
Morgan
Talladega

CALIFORNIA

Santa Barbara
Ventura

COLORADO

Adams
Arapahoe
Baca
Bent
Boulder
Chaffee
Cheyenne
Clear Creek
Crowley
Custer
Delta
Denver
Dolores
Douglas
El Paso
Elbert
Fremont
Garfield
Gilpin
Grand
Gunnison
Huerfano
Jackson
Jefferson
Kiowa
Kit Carson
Lake
Larimer
Las Animas
Lincoln
Logan

Mesa

Moffat
Montezuma
Montrose
Morgan
Otero
Ouray
Park
Phillips
Pitkin
Prowers
Pueblo
Rio Blanco
San Miguel
Summit
Teller
Washington
Weld
Yuma

CONNECTICUT

Fairfield
Middlesex
New Haven
New London

GEORGIA

Cobb
De Kalb
Fulton
Gwinnett

IDAHO

Benewah
Blaine
Boise
Bonner
Boundary
Butte
Camas
Clark
Clearwater
Custer
Jackson
Elmore
Fremont
Gooding
Idaho
Kootenai
Latah
Lemhi
Shoshone
Valley

ILLINOIS

Adams
Boone
Brown
Bureau
Calhoun
Carroll
Cass
Champaign
Coles
De Kalb
De Witt
Douglas
Edgar
Ford
Fulton
Greene
Grundy
Hancock
Henderson
Henry
Iroquois
Jersey
Jo Daviess
Kane
Kendall
Knox
La Salle
Lee
Livingston
Logan
Macon
Marshall
Mason
McDonough
McLean
Menard
Mercer
Morgan
Moultrie
Ogle
Peoria
Piatt
Pike
Putnam
Rock Island
Sangamon
Schuyler
Scott
Stark
Stephenson

Tazewell

Vermilion
Warren
Whiteside
Winnebago
Woodford

INDIANA

Adams
Allen
Bartholomew
Benton
Blackford
Boone
Carroll
Cass
Clark
Clinton
De Kalb
Decatur
Delaware
Elkhart
Fayette
Fountain
Fulton
Grant
Hamilton
Hancock
Harrison
Hendricks
Henry
Howard
Huntington
Jay
Jennings
Johnson
Kosciusko
Lagrange
Lawrence
Madison
Marion
Marshall
Miami
Monroe
Montgomery
Noble
Orange
Putnam
Randolph
Rush
Scott

Shelby

Steuben
St. Joseph
Tippecanoe
Tipton
Union
Vermillion
Wabash
Warren
Washington
Wayne
Wells
White
Whitley

IOWA

All Counties

KANSAS

Atchison
Barton
Brown
Cheyenne
Clay
Cloud
Decatur
Dickinson
Douglas
Ellis
Ellsworth
Finney
Ford
Geary
Gove
Graham
Grant
Gray
Greeley
Hamilton
Haskell
Hodgeman
Jackson
Jewell
Johnson
Kearny
Kingman
Kiowa
Lane
Leavenworth
Lincoln
Logan

Marion

Marshall
McPherson
Meade
Mitchell
Nemaha
Ness
Norton
Osborne
Ottawa
Pawnee
Phillips
Pottawatomie
Pratt
Rawlins
Republic
Rice
Riley
Rooks
Rush
Russell
Saline
Scott
Sheridan
Sherman
Smith
Stanton
Thomas
Trego
Wallace
Washington
Wichita
Wyandotte

KENTUCKY

Adair
Allen
Barren
Bourbon
Boyle
Bullitt
Casey
Clark
Cumberland
Fayette
Franklin
Green
Harrison
Hart
Jefferson
Jessamine

Lincoln

Marion
Mercer
Metcalfe
Monroe
Nelson
Pendleton
Pulaski
Robertson
Russell
Scott
Taylor
Warren
Woodford

MAINE

Androscoggin
Aroostook
Cumberland
Franklin
Hancock
Kennebec
Lincoln
Oxford
Penobscot
Piscataquis
Somerset
York

MARYLAND

Baltimore
Calvert
Carroll
Frederick
Harford
Howard
Montgomery
Washington

MASSACHUSETTS

Essex
Middlesex
Worcester

MICHIGAN

Branch
Calhoun
Cass
Hillsdale
Jackson
Kalamazoo

Lenawee

St. Joseph
Washtenaw

MINNESOTA

Becker
Big Stone
Blue Earth
Brown
Carver
Chippewa
Clay
Cottonwood
Dakota
Dodge
Douglas
Faribault
Fillmore
Freeborn
Goodhue
Grant
Hennepin
Houston
Hubbard
Jackson
Kanabec
Kandiyohi
Kittson
Lac Qui Parle
Le Sueur
Lincoln
Lyon
Mahnomon
Marshall
Martin
McLeod
Meeker
Mower
Murray
Nicollet
Nobles
Norman
Olmsted
Otter Tail
Pennington
Pipestone
Polk
Pope
Ramsey
Red Lake
Redwood

Renville

Rice
Rock
Roseau
Scott
Sherburne
Sibley
Stearns
Steele
Stevens
Swift
Todd
Traverse
Wabasha
Wadena
Waseca
Washington
Watsonwan
Wilkin
Winona
Wright
Yellow Medicine

MISSOURI

Andrew
Atchison
Buchanan
Cass
Clay
Clinton
Holt
Iron
Jackson
Nodaway
Platte

MONTANA

Beaverhead
Big Horn
Blaine
Broadwater
Carbon
Carter
Cascade
Chouteau
Custer
Daniels
Dawson
Deer Lodge
Fallon
Fergus

Flathead

Gallatin
Garfield
Glacier
Granite
Hill
Jefferson
Judith Basin
Lake
Lewis and Clark
Liberty
Lincoln
Madison
McCone
Meagher
Mineral
Missoula
Park
Phillips
Pondera
Powder River
Powell
Prairie
Ravalli
Richland
Roosevelt
Rosebud
Sanders
Sheridan
Silver Bow
Stillwater
Teton
Toole
Valley
Wibaux
Yellowstone
National Park

NEBRASKA

Adams
Boone
Boyd
Burt
Butler
Cass
Cedar
Clay
Colfax
Cuming
Dakota
Dixon

Dodge	Somerset	Steuben	Licking	Indiana	Edmunds	Lewis	Fairfax	Jefferson	Big Horn
Douglas	Sussex	Sullivan	Logan	Juniata	Faulk	Lincoln	Falls Church	Marshall	Campbell
Fillmore	Warren	Tioga	Madison	Lackawanna	Grant	Loudon	Fluvanna	Mercer	Carbon
Franklin	NEW MEXICO	Tompkins	Marion	Lancaster	Hamlin	Marshall	Frederick	Mineral	Converse
Frontier	Bernalillo	Ulster	Mercer	Lebanon	Hand	Maury	Fredericksburg	Monongalia	Crook
Furnas	Colfax	Washington	Miami	Lehigh	Hanson	McMinn	Giles	Monroe	Fremont
Gage	Mora	Wyoming	Montgomery	Luzerne	Hughes	Meigs	Goochland	Morgan	Goshen
Gosper	Rio Arriba	Yates	Morrow	Lycoming	Hutchinson	Monroe	Harrisonburg	Ohio	Hot Springs
Greeley	San Miguel	N. CAROLINA	Muskingum	Mifflin	Hyde	Moore	Henry	Okanogan	Johnson
Hamilton	Santa Fe	Alleghany	Perry	Monroe	Jerauld	Perry	Highland	Pend Oreille	Laramie
Harlan	Taos	Buncombe	Pickaway	Montgomery	Kingsbury	Roane	Lee	Pendleton	Lincoln
Hayes	NEVADA	Cherokee	Pike	Montour	Lake	Rutherford	Lexington	Pocahontas	Natrona
Hitchcock	Carson City	Henderson	Preble	Northampton	Lincoln	Smith	Louisa	Preston	Niobrara
Hurston	Douglas	Mitchell	Richland	Northumberland	Lyman	Sullivan	Martinsville	Skamania	Park
Jefferson	Eureka	Rockingham	Ross	Perry	Marshall	Trousdale	Montgomery	Spokane	Sheridan
Johnson	Lander	Transylvania	Seneca	Schuylkill	McCook	Union	Nottoway	Stevens	Sublette
Kearney	Lincoln	Watauga	Shelby	Snyder	McPherson	Washington	Orange	Summers	Sweetwater
Knox	Lyon	N. DAKOTA	Stark	Sullivan	Miner	Wayne	Page	Wetzel	Teton
Lancaster	Mineral	All Counties	Summit	Susquehanna	Minnehaha	Williamson	Patrick	WISCONSIN	Uinta
Madison	Pershing	OHIO	Tuscarawas	Tioga	Moody	Wilson	Pittsylvania	Buffalo	Washakie
Nance	White Pine	Adams	Union	Union	Perkins	UTAH	Powhatan	Crawford	
Nemaha		Allen	Van Wert	Venango	Potter	Carbon	Pulaski	Radford	Dane
Nuckolls	NEW YORK	Ashland	Warren	Westmoreland	Roberts	Duchesne	Roanoke	Rockbridge	Dodge
Otoe	Albany	Auglaize	Wayne	Wyoming	Sanborn	Grand	Rockingham	Rockingham	Door
Pawnee	Auglaize	Belmont	Wyandot	York	Spink	Piute	Russell	Russell	Fond du Lac
Phelps	Broome	Butler	PENNSYLVANIA	RHODE ISLAND	Stanley	Sanpete	Salem	Scott	Grant
Pierce	Cattaraugus	Carroll	Adams	Kent	Sully	Sevier	Scott	Shenandoah	Green
Platte	Cayuga	Champaign	Allegheny	Washington	Turner	Uintah	Shenandoah	Smyth	Green Lake
Polk	Chautauqua	Clark	Armstrong	Beaver	Union	VIRGINIA	Shenandoah	Smyth	Iowa
Red Willow	Chemung	Clinton	Beaver	Bedford	Walworth	Alleghany	Shenandoah	Smyth	Jefferson
Richardson	Chenango	Columbiana	Bedford	Berks	Yankton	Appomattox	Spotsylvania	Stafford	Lafayette
Saline	Columbia	Coshocton	Blair	Bradford	TENNESSEE	Augusta	Stafford	Staunton	Langlade
Sarpy	Cortland	Crawford	Bradford	Bucks	Anderson	Bath	Staunton	Tazewell	Marathon
Saunders	Delaware	Darke	Berks	Butler	Bedford	Bland	Tazewell	Warren	Menominee
Seward	Dutchess	Delaware	Blair	Butler	Blount	Botetourt	Warren	Washington	Pepin
Stanton	Erie	Genesee	Bradford	Cameron	Bradley	Bristol	Washington	Waynesboro	Pierce
Thayer	Genesee	Greene	Bucks	Carbon	Brookings	Brunswick	Waynesboro	Winchester	Portage
Washington	Livingston	Hamilton	Butler	Centre	Brown	Buckingham	Winchester	Wythe	Richland
Wayne	Madison	Greene	Berks	Chester	Brule	Buena Vista	Rock	WASHINGTON	Rock
Webster	Onondaga	Franklin	Blair	Clarion	Buffalo	Campbell	Shawano	Berkeley	Shawano
York	Ontario	Guernsey	Blair	Clearfield	Campbell	Hamblen	St. Croix	Brooke	Vernon
NEW HAMPSHIRE	Orange	Hamilton	Bradford	Clinton	Hancock	Hancock	Walworth	Clark	Washington
Carroll	Otsego	Hancock	Berks	Columbia	Hawkins	Hickman	Washington	Ferry	Waukesha
NEW JERSEY	Putnam	Hardin_	Blair	Cumberland	Clay	Humphreys	Washington	Grant	Waupaca
Hunterdon	Rensselaer	Harrison	Bradford	Dauphin	Codington	Jackson	Greenbrier	Greenbrier	Wood
Mercer	Schoharie	Holmes	Berks	Delaware	Corson	Jefferson	Hampshire	Hancock	WYOMING
Monmouth	Schuyler	Huron	Bradford	Franklin	Davison	Knox	Hancock	Hardy	Albany
Morris	Seneca	Knox	Butler	Fulton	Deuel	Lawrence	Hardy		
			Huntingdon	Huntingdon	Douglas				

Nuts and Bolts: Installation Guide

Installation is easy.

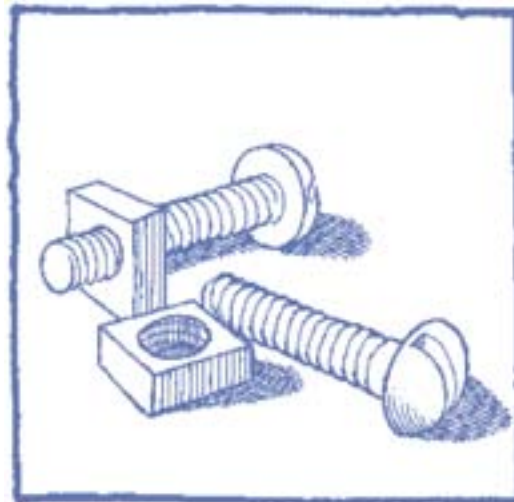

As you'll see in this chapter, installing radon-resistant features is simple, because you use common building practices and materials.

Proper installation of the radon-resistant features is very important. *Improper* installation could actually *increase* indoor radon levels.

This section gives you step-by-step instructions - the nuts and bolts - on how to install radon-resistant features.

The techniques in this document apply primarily to new one- and two- family dwellings and other residential buildings three stories or less in height.

Planning

Answer The Question: To Install Or Not To Install?

To help you answer this question, consider the following points:



Do you want to reap the benefits of installing the features?

The features not only protect your customer's health, they also affect your bottom line: your profit. A small investment up front on your part may make a big difference in return down the road, particularly as home buyers are increasingly looking for environmentally-conscious builders and healthy homes.



Are you building in a Zone 1 area?

Check the radon potential map and the list of Zone 1 counties in the previous chapter. Some states and counties have done further research on radon potential, and you can check with your state or county government to find out whether additional information is available.

If you are building in a Zone 1 area, you should install radon-resistant features in the homes that you build. Some builders also choose to install the features in Zone 2 and 3 areas, particularly if radon-resistant construction is a common practice in their area.

 Are you required by code to use radon-resistant techniques?

Some states and local jurisdictions have adopted Appendix F of the 1995 *CABO One & Two Family Dwelling Code*, Appendix D of the 1998 *International One & Two Family Dwelling Code*, or a similar code requiring installation of the radon-resistant features. The International Code Council's new International Residential Code, published in early 2000, also contains a voluntary appendix for radon-resistant construction requirements that becomes effective if the appendix is adopted with the code. If you don't already know what is required in your area, check with your local code official for more information.

 Are other builders in your area installing radon-resistant features?

If so, you may want to find out why they are installing the features, how much it costs to install the features in your area, and what the market response has been.

 Are the home buyers in your area interested in features that improve indoor air quality or energy efficiency?

A sub-slab depressurization system not only helps to reduce indoor radon levels, but also may help to reduce moisture and other soil gases. The techniques also improve energy-efficiency, which can translate into energy savings for the home buyer.

Planning Step 2

Determine What Type Of System To Install

Recommended Option

There are three general types of radon-reduction systems that builders have installed.

Passive sub-slab or sub-membrane depressurization system

It is cost-effective and recommended to install a complete passive sub-slab or sub-membrane depressurization system, which would be fully-functioning as soon as construction is finished. The home should be tested after occupancy, and the passive system should be activated if post-occupancy testing reveals radon levels at or above 4 pCi/L.

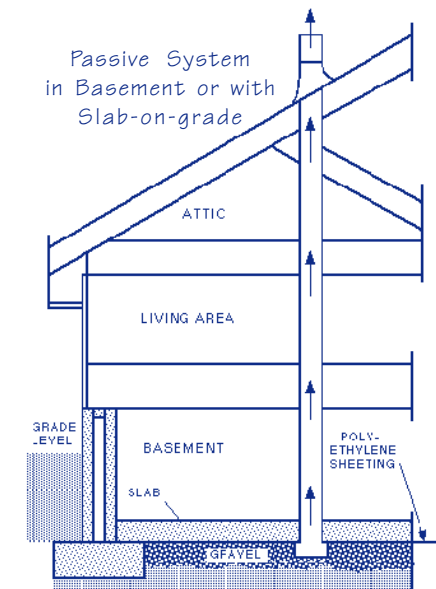
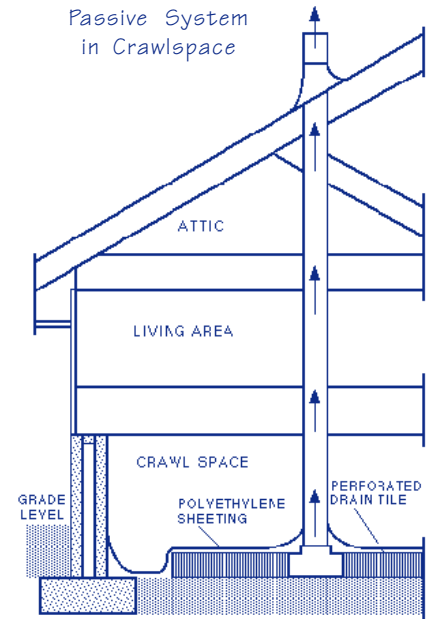

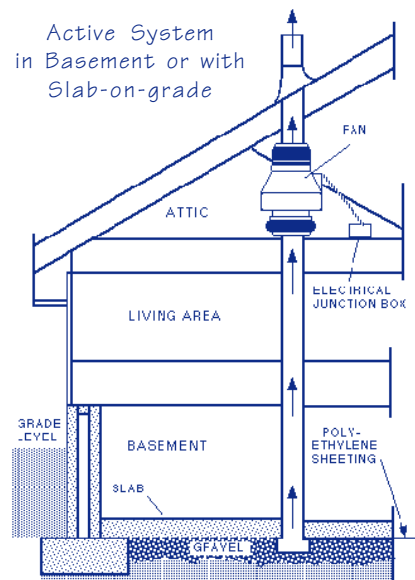

Upgraded Option

Active sub-slab or sub-membrane depressurization system

Activating a passive system by adding an in-line fan would be an effective upgrade during construction. Virtually all homes with an active system have radon levels below the 4 pCi/L action level.

Not Recommended

Passive system “rough-in”

Some builders perform only the sub-slab preparation and stub the vent pipe above the slab. A vent pipe can be connected and routed through the home and roof later if radon levels are high.

This is not the recommended approach. It is much more cost-effective to run the vent pipe through the house during construction rather than after the walls have been closed up. *However, if you elect to “rough in” a radon-reduction system, it is important to be clear with the home buyer that the home is not equipped with a functioning system. Be sure to seal off the riser stub so that radon is not being vented into the living space. Also, label the stub so it is not used as a plumbing waste line.*

Planning Step 3

Determine Vent Pipe Location And Size

Route Pipe Through Warm Spaces

The vent pipe exhausts radon collected from beneath the slab or crawlspace. One objective of a radon system in a new home is to install it in such a manner that a natural draft occurs in the pipe to draw the radon from the soil without the use of a fan. To accomplish this, route the pipe up through a warm part of the house and exhaust it through the roof.

Ideally, the vent pipe should be installed in a vertical run, with the least number of elbows which could restrict air flow. A radon vent pipe can also be run through the same chase as the furnace and water heater flue. Do not tie them together, but rather allow for enough room to route the radon vent pipe up alongside the flues with

proper clearances consistent with local building and fire codes. This means that the riser should be brought up through the slab within the same room as the furnace or water heater. This requires a little planning on your part to identify this location before the slab is poured and to allow for sufficient room in the chase.

In cold climates, do not route the pipe up through an outside wall. Routing the pipe up an outside wall will reduce the natural thermal stack effect in the vent pipe, reducing its effectiveness. It will also make it difficult to install a fan in the attic if it is needed later on. A better option is to route the pipe up through an interior wall.

In hot climates and predominantly air-conditioned houses, the passive stack will depend more on wind, a hot attic, and sun heating the pipe.

Discharge Location

To prevent radon from re-entering the house or any other nearby buildings, make sure the vent pipe exhausts:

- ✓ a minimum of 12 inches above the surface of the roof
- ✓ a minimum of 10 feet away from any windows or other openings in the building
- ✓ a minimum of 10 feet away from any windows or other openings in adjoining or adjacent buildings

If you are routing the pipe through the same chase as the furnace flue, the vent pipe needs to exit the roof at least 10 feet away from the furnace flue. Plan to elbow the pipe away from the flue in the attic to maintain this separation above the roof. However, the additional elbows and horizontal pipe length will restrict air flow through the pipe if the system is activated. Use 45 degree joints to reduce friction.

Use 4-inch Pipe When Possible

When deciding between 3-inch and 4-inch pipe (PVC or ABS), the 3-inch pipe size is the minimum you should use. However, 4-inch pipe is the preferred choice for a couple of reasons. Field results have indicated that passive systems tend to function better with 4-inch pipe. A 4-inch pipe will also allow for a quieter system if the system is activated.

Installation

The type of system you install also depends on foundation type. Please see the pages listed below which correspond to the type of foundation you will be using.

Basement or Slab-on-Grade



See page 35



Crawlspace



See page 45

Combination Foundation



Treat each foundation separately and use the appropriate techniques for each foundation segment. Pay special attention to the points at which different foundation types join, because soil-gas entry routes exist in such locations. For an alternative, see page 43.

Basement and Slab-on-Grade Construction: Sub-Slab Preparation



If the house you are building has a slab-on-grade or basement foundation, the radon gas must be able to move laterally beneath the slab to the location where the vent pipe collects the gas. There are three basic methods for improving soil gas collection beneath slabs.

Gravel

This option is generally chosen in regions of the country where gravel is plentiful and economical or where gravel is required by the building code for water drainage. A continuous four-inch layer of ½-inch to ¾-inch clean (no fines) gravel placed beneath a slab provides a largely unrestricted path for radon to be collected. This size gravel provides a drainage layer and capillary break for moisture control.

For installation guidance, see page 36.

Perforated Pipe Alternative

In some regions of the country, gravel is not a feasible option, either because native soils are sufficiently permeable and gravel is not required for water drainage, or because lack of local supply makes gravel very expensive. One alternative is to use the native fills beneath the slab and lay in a loop of perforated pipe to improve soil gas movement. This method is already employed in some homes with the use of a drain tile loop. The loop of perforated pipe works well because the soil gases need only move to the loop rather than all the way across the slab as in the case of a single collection point.

For installation guidance, see page 38.

Soil Gas Collection Mat Alternative

In some areas, the perforated pipe option may not be feasible if the labor needed to dig a trench for the pipe loop is too expensive, or if sub-grade soils are compacted or frozen. The third option is to install interconnected strips of drainage mats (soil gas mats) on top of the sub-grade and beneath the slab. Drain mats consist of plastic material that resembles an egg crate. Wrapped around the “egg crate” is a geotextile filter fabric that allows for the passage of air but prevents the infiltration of wet concrete. The mat can be laid directly on top of the prepared sub-grade, which should be a uniform layer of sand (native or fill) a minimum of four inches thick. The concrete can be poured directly over the soil gas collection mat.

For installation guidance, see page 40.

Installation Step 1A

Gravel

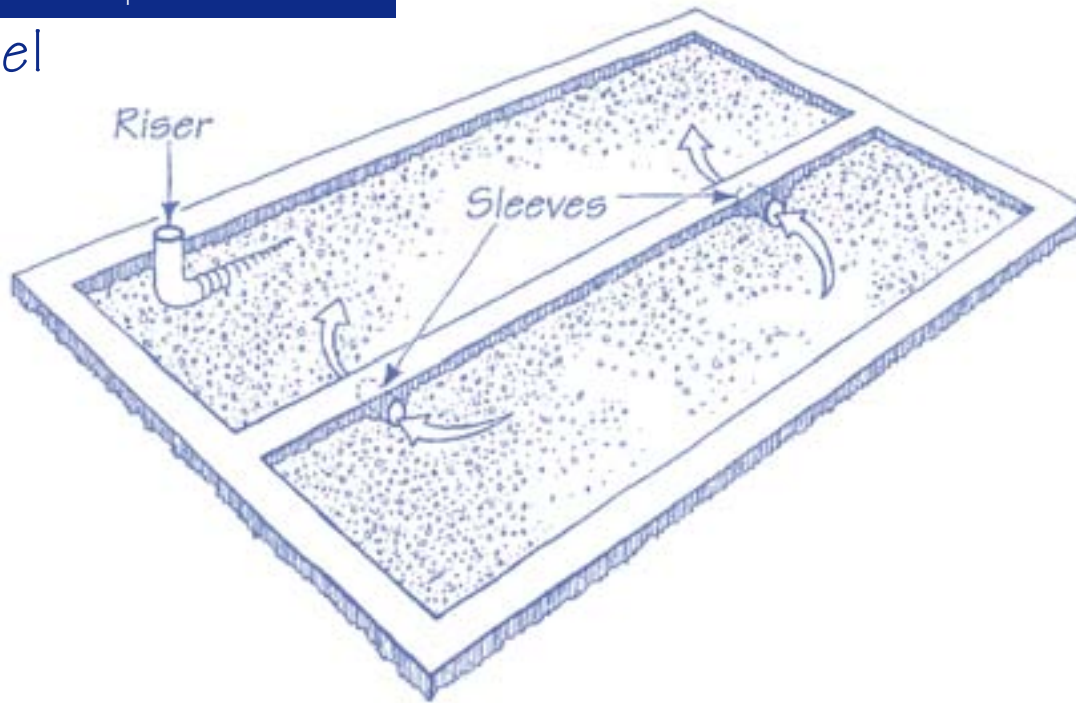

Place a uniform layer of clean aggregate under all concrete slabs or floor systems that directly contact the ground and are within the walls of the living spaces. Use a minimum 4-inch thick layer. The gravel should be about 1/2- to 3/4-inch size. Smaller or fine gravel, or gravel that is not as uniform in size, will restrict air movement under the slab.

Grade Beam Obstructions

A grade beam or intermediate footing is often installed beneath a slab to support a load-bearing wall, presenting a barrier to the lateral flow of air beneath the slab to the soil gas collection point. There are a few options that can be used to avoid grade beam obstructions to soil gas air flow.

Option 1

Use post and beam construction by setting teleposts that support overhead beams on pads rather than continuous footings.

Option 2

Provide a means for air to flow through the grade beam. This can be done by inserting at least two 4-inch pipe sleeves between the form boards or trench and pouring the grade beam over them. A minimum of two pipes should be installed at opposite ends of the grade beam. One pipe should be installed every 10 feet. Tape the ends so concrete does not enter the ends of the pipe while pouring the footing.

Remove the tape when forms are removed and before connecting to pipe loop if a pipe loop is used.

Option 3

Add a second riser on the other side of the grade beam. Tie the riser into the vertical vent stack or run a second vent stack.



Inserting Vent Pipe In Gravel

Place a 3- or 4-inch TEE fitting at the location where you want the riser to extend through the slab. The size of the TEE or elbow will depend upon the diameter of vent pipe you will be installing.

Connect a short stub, at least 8 inches, of 3- or 4-inch PVC pipe vertically into the TEE.



Recommended Improvement



Soil gas air flow can be somewhat restricted if the pipe is inserted into the gravel, and the gravel fills the pipe, especially if the system is later activated. To allow for airflow over a larger area, lay 3- or 4-inch perforated and corrugated pipe (recommended minimum length of 10 feet) in the gravel and connect it to the radon vent riser TEE fitting. Depending on the location of the riser, an elbow fitting may be used in place of a TEE fitting when using additional piping in the gravel. Make sure that the concrete does not plug up the pipe during pour.

Pipe Alternative

Perforated Pipe

Lay a 3- or 4-inch diameter perforated drain pipe in a trench around the foundation perimeter just inside the foundation footing. This could be the same pipe loop used for under-slab drainage. Be sure the pipe is covered by at least one inch of fill to keep concrete from filling perforations.

What Kind Of Pipe Works Best?

Perforated and corrugated pipe is flexible, which makes it easy to lay down in a trench. The perforations also allow for good soil gas collection. It is recommended that the pipe be covered with a geotextile cloth to prevent fines from clogging the holes.



How Much Pipe Do I Need?

Based on field work, it is recommended to lay a continuous loop of 3- or 4-inch diameter perforated pipe in the sub-grade with the top of the pipe located a nominal one inch below the concrete slab, for slab areas less than 2,000 square feet. The pipe loop should be located approximately 12 inches from the inside of the exterior perimeter foundation walls. For slab areas greater than 2,000 square feet, but less than 4,000 square feet, the same configuration may be used but the pipe size should be a minimum of 4 inches in diameter. Slab designs in excess of 4,000 square feet should have separate loops for each 2,000 to 4,000 square feet depending upon the size of pipe utilized (3-inch or 4-inch).

Install In Loops Rather Than Straight Sections

The reason for laying out the pipe in a loop is to allow for the soil gas to enter the collection pipe from two sides.

Also, if the pipe is crushed at one point during the construction, the soil gas will still be drawn to the vent pipe.

Connecting Pipe Loop To Riser

Close the loop by connecting the ends to short pipe stubs and to opposite legs of a 3- or 4-inch PVC TEE.

Connect a short stub of 3- or 4-inch PVC pipe vertically into the TEE.

Crossing Grade Beams

In buildings where interior footings or other barriers separate the sub-grade area, the loop of pipe should penetrate, or pass beneath, these interior footings and barriers. Lay the loop before the grade beams are poured, or lay a length of non-perforated but corrugated pipe across the trench before pouring a grade beam. If the latter method is used, tape off the ends of the pipe before pouring the beam, remove the tape after pouring, and finish connecting the loop.



For a more secure connection, when 3-inch corrugated pipe is used for the loop, the corrugated pipe can be inserted into a 4-inch PVC TEE by securing with sheet metal screws. When 4-inch corrugated pipe is used, 4-inch by 4-inch rubber couplings can be used to connect the perforated pipe to the solid PVC pipe stubs.

Mat Alternative

Soil Gas Collection Mat

First, install a uniform layer of sand, a minimum of four inches thick. Next, place a layer of drainage matting over the sand, or lay a loop of matting inside the exterior perimeter foundation walls (no farther than a nominal 12 inches from the perimeter foundation walls).

In buildings where interior footings or other barriers separate the sub-grade area, the matting should penetrate these interior footings or barriers to form a continuous loop around the exterior perimeter.

Slabs larger than 2,000 sq. ft., but less than 4,000 sq. ft., should have an additional strip of matting that bisects the loop, forming two areas equally impacted by the two halves of the rectilinear loop. Slab designs in excess of 4,000 sq. ft. should have successive loops of drain mat with one riser per 4,000 sq. ft. of area.

Mat material

Use a soil gas collection mat or drainage mat having minimum dimensions of one inch in height by 12 inches wide, and a nominal cross-sectional air flow area of 12 square inches. The mat matrix should allow for the movement of air through it and yet be capable of supporting the weight of the concrete above it. The matrix should be covered by a geotextile filter cloth on all four sides to prevent dirt or wet concrete from entering the matrix. Repair all breaches and joints in the geotextile cloth prior to the pouring of the slab.

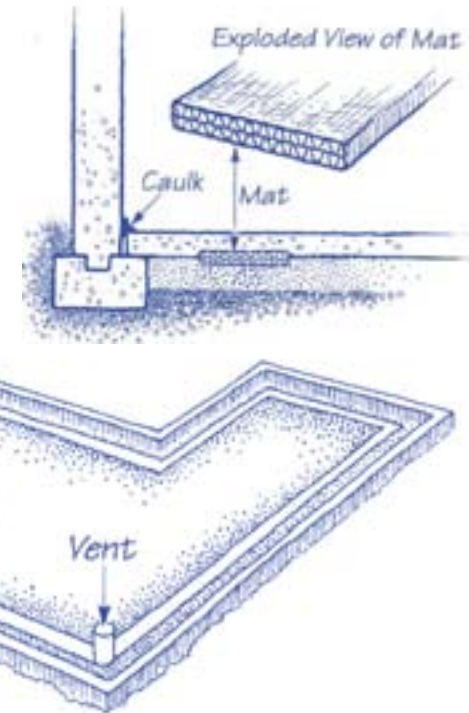

Some mats that are sold for radon reduction are only ½-inch high and only have one side covered with a geotextile cloth. If this material is used, use a minimum width of 24 inches. To keep concrete from entering the matrix, it will need to be covered with geotextile cloth. Do not cover with plastic strips because differential concrete drying can occur and cause a crack in the concrete along the edge of the plastic.

Connecting Soil Gas Collection Mat To Vent Pipe

There is a special adaptor fitting that will accept the flat mat and adapt to a round vent pipe (see graphic on right). This type of adaptor is available from soil gas collection mat and drainage mat suppliers, and from radon mitigation equipment suppliers. The mat is inserted into the flat ends and the geotextile fabric is taped to the edges to prevent wet concrete from entering the TEE. The top of the TEE is molded plastic to keep wet concrete out. After the concrete is poured, the top can be cut with a hacksaw and a 4-inch riser inserted and glued or cemented into place.

Seal Cloth Tears With Duct Tape

To insure that wet concrete does not enter the mat interior, cuts and tears should be sealed with duct tape.



Making Splices

When making splices, slit the fabric of the two ends to be joined. Lay the core from one end on top of the core from the other end with a three inch overlap. Lay the fabric back over the top of the splice and thoroughly seal with duct tape to keep the wet concrete from seeping in. Drive at least two 8-inch long staples through the mat at this point, being sure to drive them through the point where the two ends overlap.

Making TEEs in Mat

If you need to connect a length of mat in the middle of another length of mat, make a TEE by: cutting back the geotextile cloth, overlapping the interior matrix, replacing the cloth, securing with nails or landscape staples, and using duct tape to seal openings in the geotextile cloth.

Securing the Mat

To keep the mat in place while the concrete is being poured, the mat should be nailed down with 8-inch landscape staples, or 60 penny nails, about every seven feet.

Installation Step 1B

Plastic Sheeting

Laying plastic sheeting between the gas permeable layer and the concrete slab or floor assembly serves several important purposes. The sheeting can prevent concrete from flowing down and clogging the gas permeable layer. It can also bridge any cracks that may develop in the slab or floor assembly, thereby reducing soil gas entry. Finally, the plastic sheeting can act as a vapor barrier to reduce moisture and other soil gas entry into the home.

Prior to pouring the slab or placing the floor assembly, lay a minimum 6-mil (or 3-mil cross laminated) polyethylene or equivalent flexible sheeting material on top of the gas permeable layer. The sheeting should cover the entire floor area.

Separate sections of sheeting should be overlapped by at least 12 inches. Below a slab, it is not necessary to seal the joint between overlapping sheets of plastic.

Below: Thomas Dickey of the East Moline, IL Health Department inspects plastic sheeting installed for a group of townhomes.



The sheeting should fit closely around any pipe, wire or other penetrations.

Repair punctures or tears in the material. Duct tape may work for small, uniform tears or holes. For larger tears, cover with an additional piece of overlapping sheeting.

Seal Off And Label Riser Stubs

Regardless of the sub-grade collection method used, you will have a short stub of pipe sticking up to which the vent piping system will later be attached. Care should be taken to cover the end of the pipe so that it does not become filled with concrete when the slab is poured.

Label this stub so that someone does not mistakenly think it is tied to the sewer and set a commode on it.

Support the stub, perhaps off a wall, so that it stays vertical as the wet concrete is poured.



Alternative For Combination Foundations

Some builders have found it to be more economical to tie the different foundations together into a single riser. Place a pipe to connect the sub-grade area to the crawl space in the trench of the intervening footing prior to pouring the foundation walls. This pipe should be 4-inch perforated and corrugated pipe to prevent accumulation of water, which could block air flow. Cover with geotextile cloth. Tape the ends of the cross-over to keep from getting debris in it until the pipe can be connected to the slab and crawlspace systems.

Installation Step 1D

Lay Foundation

Foundation walls and slabs should be constructed to reduce potential radon entry routes. In general, openings in walls and slabs should be minimized, and necessary openings and joints should be sealed.

Foundation Walls

In poured concrete walls, all control joints, isolation joints, and any other joints should be caulked with an elastomeric sealant such as polyurethane caulk.

Hollow block masonry walls typically have cavities that can allow radon movement. To prevent this, hollow block walls should be topped with a continuous course of solid block or be grouted solid on the top. Alternatively, use a solid concrete beam at or above the finished ground level or a full sill plate.

Dampproof foundation walls, and seal any penetrations through the walls.

Slab

Pour a strong slab, and take steps to control cracking. Although concrete slabs will almost inevitably crack, control joints can help the concrete to crack in planned locations. As with the foundation walls, all control joints or other joints should be sealed with polyurethane caulk to reduce radon entry.

Do not deliberately puncture holes in the plastic sheeting prior to pouring the slab. Some contractors will do this to allow excess water to drain from the wet concrete. Putting holes in the plastic sheeting decreases (but does not eliminate) its effectiveness as a soil-gas retarder. It is preferable to use concrete with a lower water-to-cement ratio (low slump concrete).

Similarly, some contractors will put a layer of sand on top of the polyethylene, both to protect it and to absorb water from the concrete mix. This practice is not recommended. The sand may become wet, from the concrete or rising ground water, and would have to dry to the interior through the concrete. The presence of the polyethylene sheeting during this drying process may cause moisture problems above the slab.

Trap any condensate or floor drains which pass through the slab, or route them through non-perforated pipe to daylight. Mechanical traps should be used rather than “wet” traps which can dry out.

Sump pits which are open to the soil or fed by drain tile loops should be covered with a gasketed lid. For more information on sumps, see page 52.

Crawlspace Construction

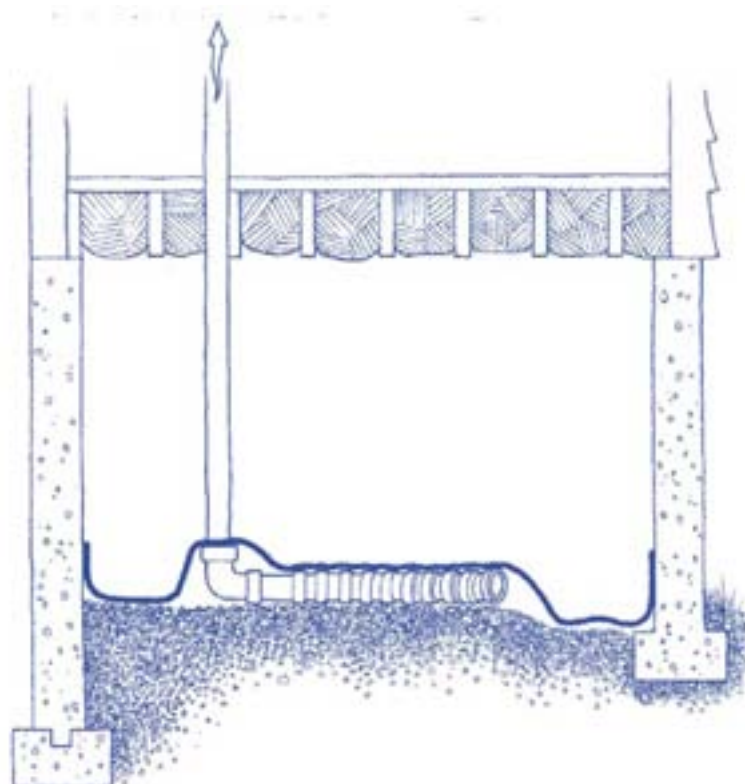

Crawlspaces are best treated by covering the entire crawlspace floor with plastic sheeting, laying a perforated collection pipe beneath the plastic sheeting, and connecting the pipe to the radon vent riser.

Crawlspaces should be constructed consistent with applicable building codes.

Access doors and other openings or penetrations between basements and adjoining crawlspaces should be closed, gasketed, or otherwise sealed with materials that prevent air leakage.

Crawlspaces Continued

Location Of Riser

The riser can be located anywhere in the crawlspace. It does not need to be in the center, so plan on placing it anywhere in the crawlspace that will be convenient for crawlspace access and for routing the pipe up through the house.

Install Pipe

Lay a length (usually five feet or more) of 3- or 4-inch diameter corrugated and perforated pipe or a strip of geotextile drain matting on the soil at the location where you will run the radon vent pipe up.

Install Plastic Sheeting

Clear the crawlspace area of objects which may puncture the plastic sheeting.

Lay a continuous layer of minimum 6-mil (or 3-mil cross-laminated) polyethylene sheeting or equivalent membrane material to cover the entire crawlspace area.

Amount Of Plastic

Plan enough plastic to allow you to overlap seams by 12 inches. The edges should also be brought up on the foundation walls about 12 inches to allow for proper adhesion. It is critical to allow for enough excess plastic so if a vacuum is drawn underneath the plastic, the plastic can conform to the surface of the crawlspace floor (like vacuum packaging). If the amount of excess plastic is insufficient, the plastic may stretch over a depression in the dirt like a trampoline.

Special Precautions

It may be necessary to take special precautions to ensure that the plastic sheeting will not be damaged after occupancy. In high traffic areas, the polyethylene should be overlain by heavier material along expected traffic routes. Various materials have been used for this purpose, including roofing felt, EPDM rubberized roofing membrane, and drainage mat. Also, if there may be foot traffic over the entire crawlspace floor, or if the crawlspace has very irregular floors, such as sharp protruding rocks, it may be advisable to use thicker cross-laminated plastic sheeting or to lay a heavier material underneath the polyethylene, between the sheeting and the crawlspace floor.



Type Of Plastic

The minimum thickness of plastic is a 6-mil polyethylene sheeting. However, this material is not very durable if the crawlspace will be accessed frequently or if occupants would like to use this area as storage. Regular 8- to 10-mil sheeting would provide better puncture resistance. High-density, cross-laminated polyethylene has even greater puncture resistance and is stronger and more durable. Unlike the regular polyethylene sheeting, which can be torn by hand even with a thickness of 10 mil, the high-density cross-laminated material cannot be torn by hand, even though its thickness may be only 4 mil. Due to its significantly increased puncture resistance, the cross-laminated polyethylene is recommended. The high-density sheeting is also available in white, making the crawlspace brighter and most suitable for use as storage space.

Crawlspaces Continued

Optional Improvement: Sealing seams and edges of plastic sheeting

Sealing The Sheeting

Although not required in current radon-resistant construction building codes, increasing the air-tightness of the seams in the plastic sheeting may enhance the system's effectiveness and integrity. Sealing should be sufficiently durable to withstand anticipated traffic through the crawlspace. To effectively seal the plastic sheeting, use a ½-inch wide bead of caulk.

Type Of Caulk

Polyurethane caulk will provide some adhesion to the polyethylene sheeting. However acoustical sealant, butyl rubber, or butyl acrylic caulks form a more durable bond with the plastic. Field work suggests that other proprietary sealants are also effective, such as Proflex by GeoCel.

Sealing Seams

Seams between adjoining sheets of sheeting are usually sealed by

applying a continuous bead of sealant between the sheets in the 12-inch strip where the sheets overlap. Firmly press the overlapping sheets together.

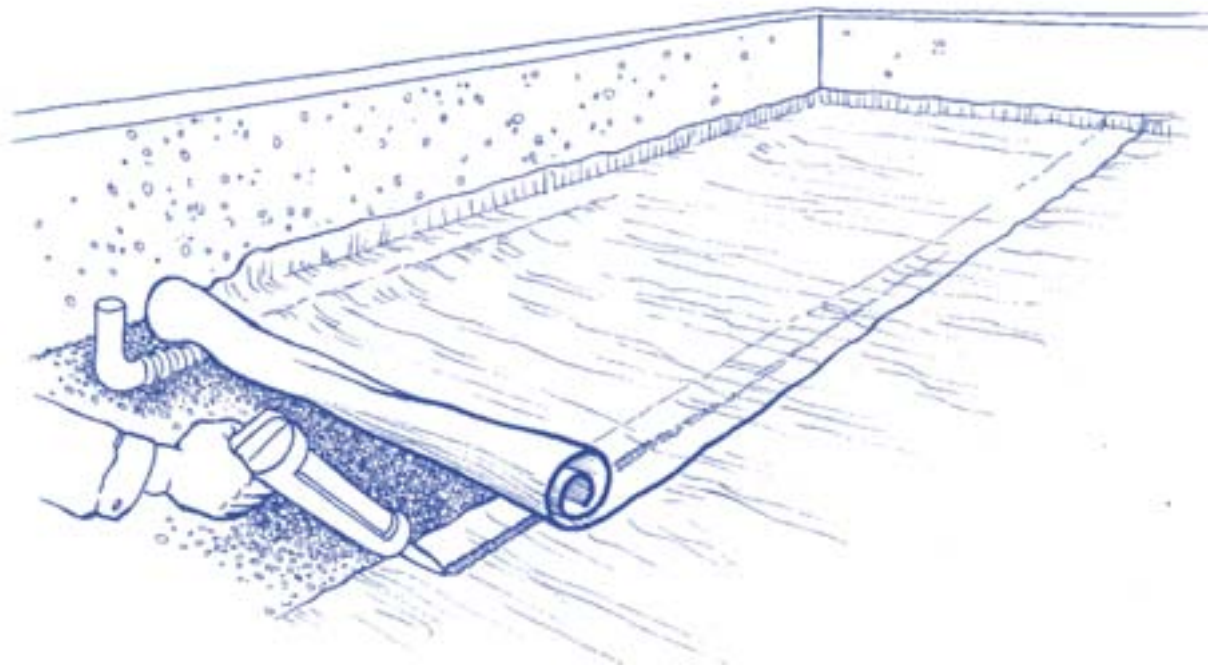

Sealing Edges And Seams

Brush the walls with a wire brush at 6 to 12 inches above the crawlspace floor to remove any dirt or loose deposits.

Make sure the sheeting lays flat on the crawlspace floor right

Plan on using one 11-ounce tube of caulk to attach an 8-foot length of plastic to the wall.

up to the wall. Leave several inches of slack on the vertical section of the plastic rising up the wall to help prevent the plastic from pulling on the seam due to foot traffic or by the system itself when it is functioning.

Secure plastic to the wall at 6 to 12 inches above the crawlspace floor with a ½-inch wide bead of acoustical sealant or butyl caulk along the wall.

For a more durable connection, consider using mechanical fasteners, such as strapping, to hold the plastic to the wall. If there is an obstruction to the wall within six to 12 inches of the floor, such as a crawlspace access door,

trim the sheeting to pass beneath the obstruction and caulk the sheeting to the wall around the obstruction. At corners, cut and tuck plastic sheeting neatly, and make sure that the sealing is also airtight.

Keeping Plastic In Place

While the caulk is curing, use duct tape along the seam to hold the sheets together. The tape can secure the seam to keep the seam from breaking during the cure as workers complete the installation. When sealing edges, it is also a good idea to temporarily tape the free edge of the plastic so it will stay in place as the caulk cures. Place weights on the plastic to keep it from being pulled off the walls as you work on the balance of the crawlspace.

Vertical Penetrations

The sheeting needs to be sealed around posts and plumbing lines. It is easier to seal a large sheet to a flat apron section than to try to fit it around the obstacle. You can use scraps of plastic to form an apron to fit around these obstructions. Also, try to plan your seams along rows of piers. When sealing around plumbing risers, make sure that the clean-out is accessible.



Crawlspaces Continued

Riser Installation

The vent pipe needs to be connected to the perforated pipe beneath the plastic in a manner that prevents air leakage. The plastic sheeting can be wrapped around the vent pipe and taped to the pipe securely.

Another way to prevent air leakage around the joint is to use two roof flashing hoods. One roof flashing goes below the plastic and one is placed above the plastic to provide a flat area to which the plastic can be sealed. The riser is sealed by the rubber grommet on the roof flashing. The two roof flashings are then secured by sheet metal screws. Depending on the location of the riser, there may be either a PVC TEE or an elbow beneath the plastic that has a short 4-inch stub of pipe to which the corrugated and perforated pipe will be connected.

Label Riser And Plastic

It is a very good idea to label the riser within the crawlspace so it is not confused with any other plumbing. It is also a good idea to label the plastic to state that the plastic should not be removed and, if cut, it should be patched or replaced.

After home construction is completed, inspect the sheeting for damage and repair as necessary.

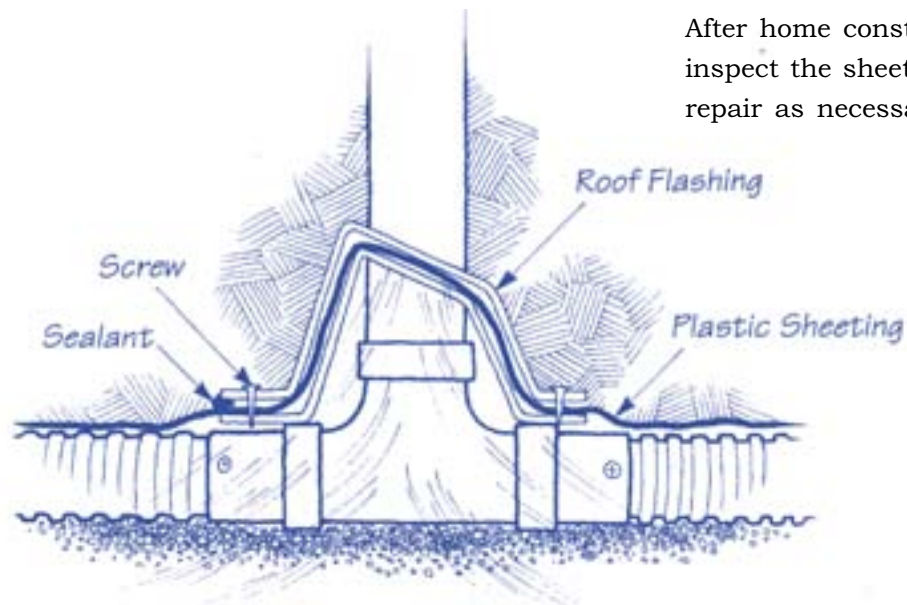

Seal Openings

After you pour the slab or place the floor assembly, seal major openings in the slab to retard soil gas entry through openings in the slab or floor assembly.

Use materials that provide a permanent airtight seal such as non-shrink mortar, grouts, expanding foam, or similar materials. When caulking slab openings, it is best to utilize a polyurethane caulk which has excellent adhesion characteristics for concrete. The following are some examples of locations to be caulked after the concrete slab has cured and before framing is installed.

Seal Floor-To-Wall-Joints

Floor-to-wall joints are critical places to seal. Brush debris away from the joint before applying caulk. Apply enough caulk so when smoothed with a piece of cardboard cut in a convex form, the caulk will come out onto the floor and up on the wall about 3/8-inch. The table on this page indicates the approximate length of joint that an 11-ounce tube of caulk will cover.

Joint Type	Feet per 11 oz. Tube
Cold	12
Expansion	8

Seal control joints

Control joints in the concrete slab, whether they are saw cut or made with grooving tools, should be cleaned and filled with caulk. Even if they are not cracked initially, they will likely develop cracks in the future and caulking them before the floor finishes are in place makes sense. A gun-grade polyurethane or a flowable polyurethane can be used. This seal does not interfere with the expansion of the control joint, but does block radon entry.

Installation Step 3 Continued

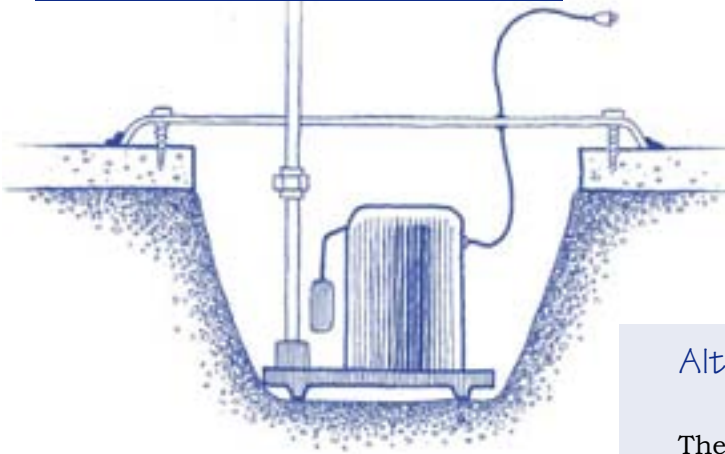

Seal Open Sumps

An open sump may allow radon into the house from beneath the entire house foundation. Make sure to cover and seal the sump. The sump cover, which must be removable to allow for regular maintenance and inspection of the sump pump, is usually sealed by bolting it directly to the slab or sump-liner lip and made airtight through the use of a gasket or silicone-caulk seal.

If the sump is intended as a floor drain, make sure the lid is equipped with a trapped drain to handle surface water on the slab.

Alternative: Tie Into Sumps

The sump can also be incorporated into the radon system.

If the sump is used without a drain tile loop, install a sump pit cover specifically designed to accommodate a radon vent pipe and run the vent pipe directly from the sump. These sump covers are available from numerous building supply stores, as well as catalog firms dealing in equipment and supplies for radon mitigation contractors.

If the sump pit where the radon vent pipe will be located also includes a pump, a cover can be ordered that includes both an opening for the radon vent pipe as well as holes for the pump's water discharge line and electrical connection. Because sump-cover removal and resealing is required every time pump

maintenance is performed, consider using a sump cover with a transparent "door" or see-through viewing window. These doors, which are usually screwed into the cover and sealed with a gasket, are generally large enough to permit limited access to the pump switch without removing the sump cover and breaking the seal. Windowed sump covers are available for less than \$50.

If the sump is connected to a drain tile loop, the radon vent pipe could be inserted directly into the sump or into any convenient section of the drain tile loop (then cover and seal the open sump). Although installing the radon vent pipe in a remote section of the drain tile loop is slightly more difficult than directly into the sump, it may offer a better exhaust route through the home's interior spaces and may offer the homeowner simplified access to the sump.



Other Places To Seal The Slab And Foundation

Use a polyurethane caulk around locations where plumbing and other utility service lines pass through slab and below-grade walls.

Use a full sill plate over the upper row of block walls in basements or make the upper row solid block.

Seal hollow block foundation walls at the top. Use at least one continuous course of solid masonry, one course of masonry grouted solid, or a poured concrete beam at or above finished ground surface. Where a brick veneer or other masonry ledge is installed, the course immediately below that ledge should be sealed.

Caulk joints, cracks, or other openings around all penetrations of both exterior and interior surfaces of masonry block or wood foundation walls below the ground surface. Penetrations of poured concrete walls should also be sealed on the exterior surface. This includes sealing wall tie penetrations.

Installation Step 3 Continued

Other Considerations

Placing air handling ducts in or beneath a concrete slab floor, or in other areas below grade is not recommended unless the air handling system is designed to maintain *continuous* positive pressure within the ductwork. This is to prevent radon from being drawn into the ductwork and then distributed throughout the house.

If ductwork does pass through a crawlspace or beneath a slab, it should be of seamless material or sealed tightly. Where joints in the ductwork are unavoidable, seal to prevent air leakage.

Placing air handling units in crawlspaces, or in other areas below grade and exposed to soil gas, is not recommended. However, if they are installed in these areas, make sure that they are designed or sealed in a durable manner to prevent air surrounding the unit from being drawn into the unit.

Avoid using floor drains and air conditioning condensate drains which discharge directly into the soil below the slab or into the crawlspace. If installed, these drains should be routed through solid pipe to daylight or through a trap approved for use in floor drains. Mechanical traps should be used rather than “wet” traps which can dry out.

The bottom of channel-type (French) drains should be sealed with a backer rod and caulking. Water drainage should be directed to a suitable drain.

Install Vent Pipe

Be sure to run the pipe up through the roof before the roofer installs the roof system. This will allow the roofer to properly flash around the pipe. Avoid angles in the pipe, if possible, to increase air flow through the vent pipe and maximize radon reduction.

Type Of Pipe

Use Schedule 40 PVC or ABS pipe. The pipe does not need to be pressure rated, so a pipe rated for Drain, Waste and Vent (DWV) applications will be the most cost effective. Do not use a pipe thinner than Schedule 40. Do not use sheet-metal ductwork due to the likelihood of breakage or leaks at joints.

All joints should be primed and glued in a similar manner as indoor plumbing.

Do Not Trap Pipe

Plan your pipe routing to minimize the length of pipe and fittings and to contain no traps.

Do not install traps, intentional or accidental, in the pipe that will collect water and restrict or stop air movement. Air from the soil will have some moisture in it. As this air moves through sections of the vent pipe located in cold spaces, such as an attic, some moisture can condense. It is important that this water can drain back down to the soil. Insulating the pipe in the attic will reduce moisture condensation and maintain upward thermal draft in the pipe as it passes through unconditioned space.

Piping should also slope back to the suction pipe at a minimum angle of 1/8 inch per foot.



Use either PVC or ABS pipe, not both. The two types of pipe require different cleaners and cements.

Installation Step 4 Continued

Allow For Future Installation Of Fan

Although passive radon systems are effective for reducing radon levels by an average of about 50%, it is always a good idea to plan ahead in case adding an in-line fan is needed for further radon reduction to bring indoor levels below 4.0 pCi/L, or in case the future occupant wants to lower the radon levels as much as possible. During installation of the vent pipe, consider these criteria for locating a future fan:

- ✓ Fan cannot be inside the living space of the house.
- ✓ Fan cannot be in the crawlspace beneath the home.
- ✓ Fans are most often located in attics or garages (unless there is living space above the garage).
- ✓ Fans require a 30-inch vertical run of pipe for installation.
- ✓ Fans require an unswitched electrical junction box.

Maintain Fire Resistive Rating Of Walls And Ceilings

If you route your vent pipe through the wall between the house and the garage, you will need to put a fire-barrier around the pipe (on the inside of the garage) to maintain the integrity of the wall. Install a fire barrier with a rating equal to the wall.

Note that some ceilings are also fire rated ceilings and will require fire barriers as well.

Label Radon Vent Pipe

Label the exposed portions of the pipe so other people will know that the pipe is not part of the sewer system during construction. It is recommended that the radon vent system be labeled in a conspicuous location on each floor level. Also, occupants and future occupants will know that it is part of a “radon vent system.”

Places to label include:

- ✓ Where riser exits slab
- ✓ Where pipe is seen in closets
- ✓ Pipe run through attic



Recommended Improvement: Screen On Discharge

It is a good idea to put a 1/4-inch mesh screen on the discharge to keep birds from nesting in the pipe.

Rain caps can reduce radon flow and can force radon (if the system is activated) back down towards the openings into the living spaces. In most areas, they are not needed. For very high rainfall areas, use alternative special devices which prevent large amounts of rain from entering the system while still allowing the air to vent up and away from the building. These devices are available through radon mitigation supply distributors. Another design option, which is more commonly used with commercial applications than with residential installations, is an annular rain cap as pictured here.



Installation Tip

Support the pipe

Support the pipe using plumbers strapping at least once every 6 feet in horizontal runs and once every 8 feet in vertical runs.

Insulate the pipe

In cold climates, insulate the pipe where the pipe is routed through unheated spaces, such as the attic.

Installation Step 5

Seal Ducts and Air-Handling Units

HVAC systems should be carefully designed, installed and operated to avoid depressurization of basements and other areas in contact with the soil. Ideally, ductwork should remain in the conditioned space of the home. It is very important to seal joints in air ducts and plenums passing through unconditioned spaces such as attics, crawlspaces, or garages.

In addition to avoiding problems with unwanted air distribution, sealing ducts can save energy, make homes more comfortable, and lower heating and cooling costs.

Install Electrical Junction Box

For Future Installation of Fan

Although in most cases the passive system alone is enough to keep radon levels below 4 pCi/L, occasionally the homeowner will want or need to activate the system by adding a fan to further lower radon levels in the home. To prepare for this possibility, pre-wire the attic when installing a passive system. An unswitched electrical junction box should be installed in the attic or garage within 6 feet of the vent pipe. (See page 56 for a discussion about fan installation location.)

For attics with interior access, many building codes require a light in the attic. In these cases, if the junction box for the light is located at an appropriate location for the fan, another junction box will not be necessary. If not, wiring the additional outlet will be simple. The fan outlet does not require a dedicated circuit; it may branch off the existing circuit for the light.

Installation Step 7

Post-Occupancy Testing



Testing is simple and easy.

After the home is complete and occupied, it should be tested to determine whether or not the passive system needs to be activated. You should recommend to the home buyer that they test the home after they move in and activate the system if the radon level is at or above 4 pCi/L.

Some builders installing passive systems are testing the homes they build and activating the passive radon systems if radon levels are at or above 4 pCi/L. In all cases you should advise the homeowners to retest sometime in the future to confirm radon levels remain low.

Obtaining a Test Kit

Radon test kits can often be obtained at your local hardware store. There are

many kinds of low-cost "do-it-yourself" radon test kits you can get through the mail and in hardware stores and other retail outlets. Coupons for short-term and long-term radon test kits are also available from the National Safety Council's web site at www.nsc.org/EHC/indoor/coupon.htm.

Types Of Radon Tests

Short-term Tests

The quickest way to test is with short-term tests. Short-term tests remain in the home for two days to 90 days, depending on the device. Because radon levels tend to vary from day to day and season to season, a short-term test is less likely than a long-term test to give the home's year-round average radon level. If you or the homeowner need results quickly, a short-term test

Note: The above figure illustrates one example of a radon testing device. There are many other types of radon testing devices available.

followed by a second short-term test may be used, or two short-term tests may be performed simultaneously.

Long-term Tests

Long-term tests remain in a home for more than 90 days. A long-term test will give a reading that is more likely to give a home's year-round average radon level than a short-term test.

How To Use a Test Kit

Follow the test kit instructions. For short-term tests, close all windows and outside doors and keep them closed throughout the test, except for normal entry and exit. If you are doing a short-term test lasting just 2 or 3 days, be sure to also close windows and outside doors at least 12 hours before beginning the test. Do not conduct short-term

tests lasting just 2 or 3 days during unusually severe storms or periods of unusually high winds, because these conditions can affect the test results.

The test kit should be placed in the lowest lived-in level of the home, for example, the basement if it is to be frequently used, otherwise the first floor. It should be put in a room that is used regularly, like a living room, playroom, den or bedroom but not the kitchen or bathroom. Place the kit at least 20 inches above the floor in a location where it won't be disturbed and away from drafts, high heat, high humidity, and exterior walls. Leave the kit in place for as long as specified in the device instructions. Once the test is completed, reseal the package and send it to the lab specified on the package right away for analysis. You should receive test results within a few weeks.

Steps For Testing

If you are conducting the radon test prior to sale of the home, you will likely want to get results as quickly as possible by following these testing steps. If a homeowner is testing the home for radon, he or she should follow the longer steps on page 69.

Step 1

Conduct a short-term test for at least 48 hours. After the first test has been completed, conduct a follow-up short-term test for at least 48 hours.

Alternatively, take two short-term tests at the same time in the same location for at least 48 hours.

Step 2

If the average of the two tests is 4 pCi/L or more, activate the passive radon reduction system.

Optional Step 8

Activating the System

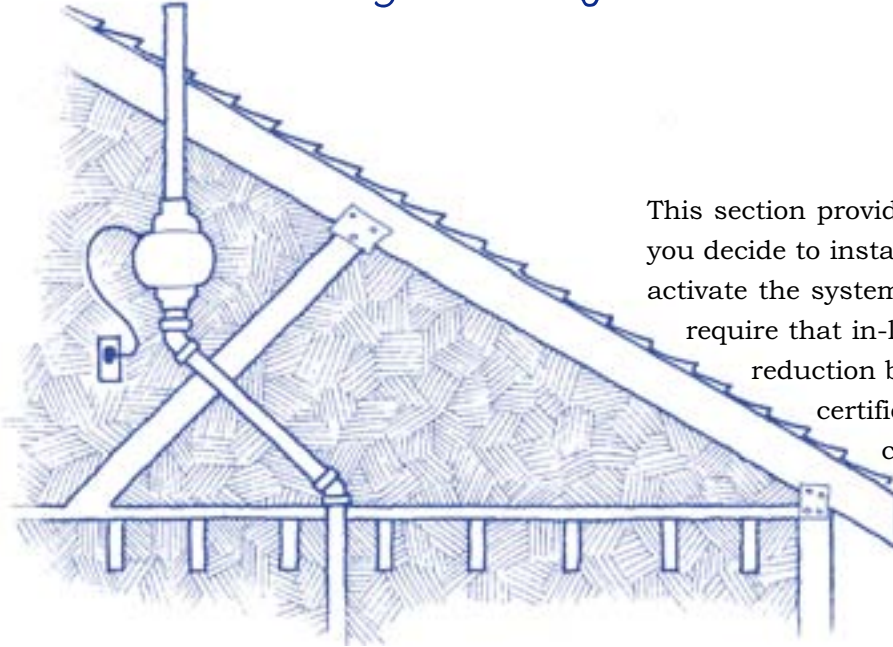

This section provides basic guidelines if you decide to install an in-line fan to activate the system. Some states require that in-line fans for radon reduction be installed by a certified radon mitigation contractor. Call your state radon contact for a list of certified contractors (see Appendix D for a list of phone numbers).

Location

The fan and all positively pressurized portions of the vent pipe should be located outside habitable space in the building.

The ideal location is in the attic, or, perhaps, in an attached garage, where the fan housing and vent pipe can be sheltered from the elements, yet be outside the building's conditioned spaces. Sheltering the fan maximizes

its efficiency and life expectancy by minimizing exposure to extreme temperatures and moisture.

Placement in a non-conditioned space prevents the accidental pumping of radon directly into a home should a leak occur in the fan housing or at the vent-pipe joints.

Building designs that call for a flat roof or cathedral ceiling, or some other design feature that makes the attic installation unworkable, may necessitate placing the fan on the roof or in an exterior venting pipe.

Appropriate fan locations:

- ✓ Unoccupied attic
- ✓ Outside the house
- ✓ In garage

Inappropriate fan locations:

- ✗ In crawlspace
- ✗ In basement
- ✗ In occupied attic

Type Of Fan

Although various types of fans are suitable for this purpose, the most commonly-used fans are centrifugal fans often referred to as “in-line,” “tubular” or “tube” fans.

The size and air movement capacity of the vent pipe fan should be sufficient to maintain a pressure field beneath the slab or crawlspace membrane that is lower than the ambient pressure above the slab or membrane. Most contractors have found 90-watt in-line fans to be adequate for most home styles, locations and sizes. You can also look for a fan capable of moving 100 cubic feet of air per minute at one inch of water column, which should be sufficient for most applications.

How To Install

Install the fan in a vertical run of the vent pipe. This will prevent outdoor precipitation from accumulating in the fan or fan housing. Do not use an angled portion of the pipe.

To reduce vibrations and noise transmission, use flexible air-tight couplings instead of rigid couplings. Secure couplings tightly to the fan using circular hose clamps.

In regions with prolonged or extreme cold, both fans and attic vent pipes should be insulated to reduce condensation and the possibility of vent exhaust “freeze up.” Freeze-up is most often found in regions with extremely cold winters and in systems having high air-flow rates as well as high moisture levels in the sub-slab soil.

Install A System Failure Warning Device

A system failure warning device should be used to alert occupants to any malfunction of the system or drop in its suction flows. Types of warning devices include pressure gauges, manometers and visual or audible alarms. Unless the indicator is integral to the fan power supply, the audible or visual alarm should be connected to a separate circuit so that it will activate if power to the fan is interrupted.

Sold: Working With Homebuyers

Get An
Edge On
The Market



Make The Radon System
A Custom Feature

Include A Brochure On
Radon Systems In All
Sales Information

All homebuyers want to know that they are buying a quality home. There are a few simple things that you can do to educate your homebuyers that radon-resistant features make sense both from a health and from an investment standpoint.

The activities suggested here are inexpensive and easy to implement. Doing them will make your company stand apart from the other builders in your area by demonstrating your commitment to customer satisfaction and healthy homes.

Prominently list the availability of a radon system as a custom feature in all your sales, promotional, and advertising materials. Emphasize the desirability of a radon system in the same way you would hardwood floors, nine-foot ceilings, upgraded appliances, master bedroom suites, etc. These are all features that enhance the value of the house and make it more enjoyable to live in. Stress the economic advantage of adding a radon system while the home is being built, thereby avoiding a more expensive, retrofit installation.

Provide a pamphlet on the basics of a radon system in all hand-out sales materials. You might include radon maps from your specific geographical area, as well as easy-to-understand information on why a radon system is important, how it operates, the costs involved, and other questions that home buyers might ask when considering a radon system. A number of useful consumer-oriented publications are available to be ordered in bulk, such as the brochure "Buying a New Home? How to Protect Your Family From Radon" and radon maps. See Appendix C for more information.



Educate Your Sales Team

All sales associates should be as knowledgeable and positive about the value of a radon system as they are about every other feature you offer. Have them stress not only the amenities you provide, but also the solid construction techniques you offer, including a radon system. Help your sales staff understand the radon system and how it works, so that they can explain its benefits to sales prospects. An on-site review of the system by a construction supervisor is an excellent way to start. In addition, have your sales personnel become familiar with your radon information materials and ask them to go over these materials with prospective home buyers.



Use Your Model Home As A Promotional Tool

Install a radon system in your model home. Advertise it as another, must-have feature that is desired by many new home buyers. Consumers expect a builder to include the “latest and greatest” product offerings in the model home; make a radon system one of those special elements and promote it accordingly.



Post Signs

Highlight the value of a radon system by placing an explanatory sign in the basement or near the crawlspace area of your model home. This will make prospective home buyers aware of the system’s availability, function, and benefits. As you prepare to install radon systems in your new homes, increase the interest of “drive-by” prospects by placing a “Radon System Being Installed” placard on the site.



Generate Buyer Awareness

To increase home buyers’ awareness of radon, consider the following promotional activities.

Print Media

Prepare a news release on the availability of your new homes. This can include a complete discussion of features, size, location, floor plans, etc. Prominently mention that you are the “only builder in your area” to offer radon systems (if this is appropriate and accurate). Explain why you have chosen to provide this important feature to members of your community.

Website Promotion

More and more consumers are relying on the internet for information about buying a new home. Develop a special web page on radon systems to integrate with your existing website.

Make A Name For Yourself

One of the most effective ways of marketing radon systems is to establish yourself as a knowledgeable builder concerned about radon and equipped to do something about it. By providing consumers with general information about radon and radon systems, you will establish yourself as a socially-responsible builder who is attentive to the health and well-being of community families. This reputation is likely to give you an edge over your competitors by making your homes more desirable to today's health-conscious consumers.

The following marketing activities are simple ways to build your reputation in the community as a knowledgeable builder of quality, radon-resistant homes.



Inform Newspaper Readers

A well-conceived “letter to the editor” on the importance of safe indoor environments, and the contribution that radon systems can make, may spark increased demand for radon systems and highlight their availability in your homes.



Alert Local Realtors

Many realtors are familiar with the radon issue as it relates to existing homes. Consider holding a seminar or informal gathering of local realtors to discuss the importance of including radon systems in new construction. Let them know that you are a builder who offers such systems in your houses and that you are willing to work with any client they may have that is concerned about the possibility of radon in their home.



Consider A Public Service Announcement

A radio public service announcement about radon's health effects and the value of a radon system in protecting people is a relatively inexpensive, but highly effective, means of increasing community awareness about radon and expanding the demand for radon systems. Your 30-second announcement can conclude by identifying your company as the sponsor of the information and a builder who is interested in protecting people from radon.



Offer Community Education Materials

Brief, informational brochures or fact sheets on radon and radon systems can be developed for free distribution in grocery stores, schools, libraries, banks, community centers, etc. These materials can help increase awareness of radon's impact on the community and the value of radon systems in reducing radon exposure. Display your company's name and logo on all educational materials you distribute.



Be A Television Star

Community television programs on "moving up" or "buying your dream home" are always of interest to consumers. Use these programs to promote radon systems. Arrange to appear on a community-based television program and use the opportunity to talk about why you offer radon systems in your homes. Local cable stations are especially good outlets for this type of activity.

What To Tell Homebuyers

Once you have sold the house, there are a few key items to tell your homebuyer about the radon features that you have installed in their new home.

What Features Have Been Installed?

Let your home buyer know whether you have installed a passive radon system, an active radon system, or a rough-in for a sub-slab depressurization system. Explain what the features are designed to do.

Passive System

If you have installed a passive system, let the homebuyer know that they should test their home for radon. Tell the homeowner that if the tests indicate a radon level at or above the action level of 4 pCi/L, it is recommended that they hire a radon mitigation contractor to activate the system, or you could offer to activate the system.

Active System

If you have installed an active system, recommend to the homebuyer that they

conduct a radon test after they have occupied the home. Let the homebuyer know where the system failure warning device is located and inform the homebuyer that if the device indicates a system failure, the fan is no longer working to vent radon out of the home. The homeowner should then contact a radon mitigation contractor to check the system.

Rough-In For Sub-Slab Depressurization

If you have installed a rough-in for sub-slab depressurization, it is very important for the homebuyer to be aware that the house has not been equipped with a functioning radon system. Explain that the home would need to be tested for radon. If the tests indicate a radon level at or above the action level of 4 pCi/L, it is highly recommended that the homebuyer hire a radon mitigation contractor to install the rest of the radon system.

Does This Mean This House Has High Radon?

Some homebuyers may be concerned that you have installed the radon system because the house has high radon levels. Simply explain that there is no way of knowing whether or not a home has high radon until the home is completed and a radon test is performed. Tell them that a passive system will reduce radon levels on average by about 50%. Also tell them that the home should be tested, and that the system should be activated if further reductions are desired or if radon levels are at or above 4 pCi/L. If the radon features had not been installed, it could cost \$800 - \$2500 to fix a radon problem after construction has been completed.

How Does The Homebuyer Test For Radon?

The following are recommended steps for the homebuyer to test for radon once they have moved into the home. These steps are slightly different from the steps outlined for builders on page 61, because the homeowner has more time to perform long-term tests.

Step 1

Conduct a short-term test for at least 48 hours. If the result is 4 pCi/L or higher, take a follow-up test (Step 2) to be sure.

Step 2

Follow up with either a long-term test or a second short-term test. For a better understanding of the year-round average radon level, take a long-term test. For faster results, take a second short-term test.

Step 3

If you followed up with a long-term test: activate the passive system if the long-term test result is 4 pCi/L or higher. If you followed up with a second short-term test: consider activating the system if the average of the two short-term tests is 4 pCi/L or higher. The higher the short-term results, the more certain you can be that you should activate a passive radon system. Once a system has been activated, the radon testing should be repeated with a short-term test (preferably between 24 hours and 30 days after activation).

Hopefully, you now see the benefit of building homes with radon-resistant features, and you are familiar with the techniques for installing the features.

The following pages contain additional information which you may find useful, including architectural drawings, and information about how to order a video by the National Home Builders Association to view the features being installed.

Become one of the many builders nationwide who are helping to reduce the risks of radon!

Architectural Drawings

On the following pages are three architectural drawings of the passive, active, and crawlspace radon reduction systems to help you visualize the complete radon features as they should be installed.

These drawing are available in a larger format as EPA document 402-F-95-012, free through the National Service Center for Environmental Publications. They are also available electronically on the EPA website in .PDF files and as CAD drawings. For more information, see Appendix C.

Architectural Drawing
 Passive Sub-Slab
 Depressurization System
 Used for basement and slab-on-grade
 construction

PASSIVE SUB-SLAB DEPRESSURIZATION RADON CONTROL SYSTEM FOR NEW CONSTRUCTION

NOTES:

1. ALL CONCRETE SLABS THAT COME IN CONTACT WITH THE GROUND SHALL BE LAD OVER A GAS PERMEABLE MATERIAL MADE UP OF EITHER A MINIMUM 4" THICK UNIFORM LAYER OF CLEAN AGGREGATE, OR A MINIMUM 4" THICK UNIFORM LAYER OF SAND, OVERLAIN BY A LAYER OF STRIPS OF MANUFACTURED MATTING DESIGNED TO ALLOW THE LATERAL FLOW OF SOIL GASES.
2. ALL CONCRETE FLOOR SLABS SHALL BE DESIGNED AND CONSTRUCTED IN ACCORDANCE WITH LOCAL BUILDING CODES, ADDITIONAL REFS: AMERICAN CONCRETE INSTITUTE PUBLICATIONS, "ACI302.1R" & "ACI332R", OR THE POST TENSIONING INSTITUTE MANUAL, "DESIGN AND CONSTRUCTION OF POST-TENSIONED SLABS ON GROUND".
3. ALL OPENINGS, GAPS AND JOINTS IN FLOOR AND WALL ASSEMBLIES IN CONTACT SOIL OR GAPS AROUND PIPES, TOILETS, BATHTUBS OR DRAINS PENETRATING THESE ASSEMBLIES SHALL BE FILLED OR CLOSED WITH MATERIALS THAT PROVIDE A PERMANENT AIR-TIGHT SEAL. SEAL LARGE OPENINGS WITH NON-SHRINK MORTAR, GROUTS OR EXPANDING FOAM MATERIALS AND SMALLER GAPS WITH AN ELASTOMERIC JOINT SEALANT, AS DEFINED IN ASTM C920-87.
4. VENT PIPES SHALL BE INSTALLED SO THAT ANY RAINWATER OR CONDENSATION DRAINS DOWNWARD INTO THE GROUND BENEATH THE SLAB OR SOIL-GAS-RETARDER MEMBRANE.
5. CIRCUITS SHOULD BE A MINIMUM 15 AMP, 115 VOLT.

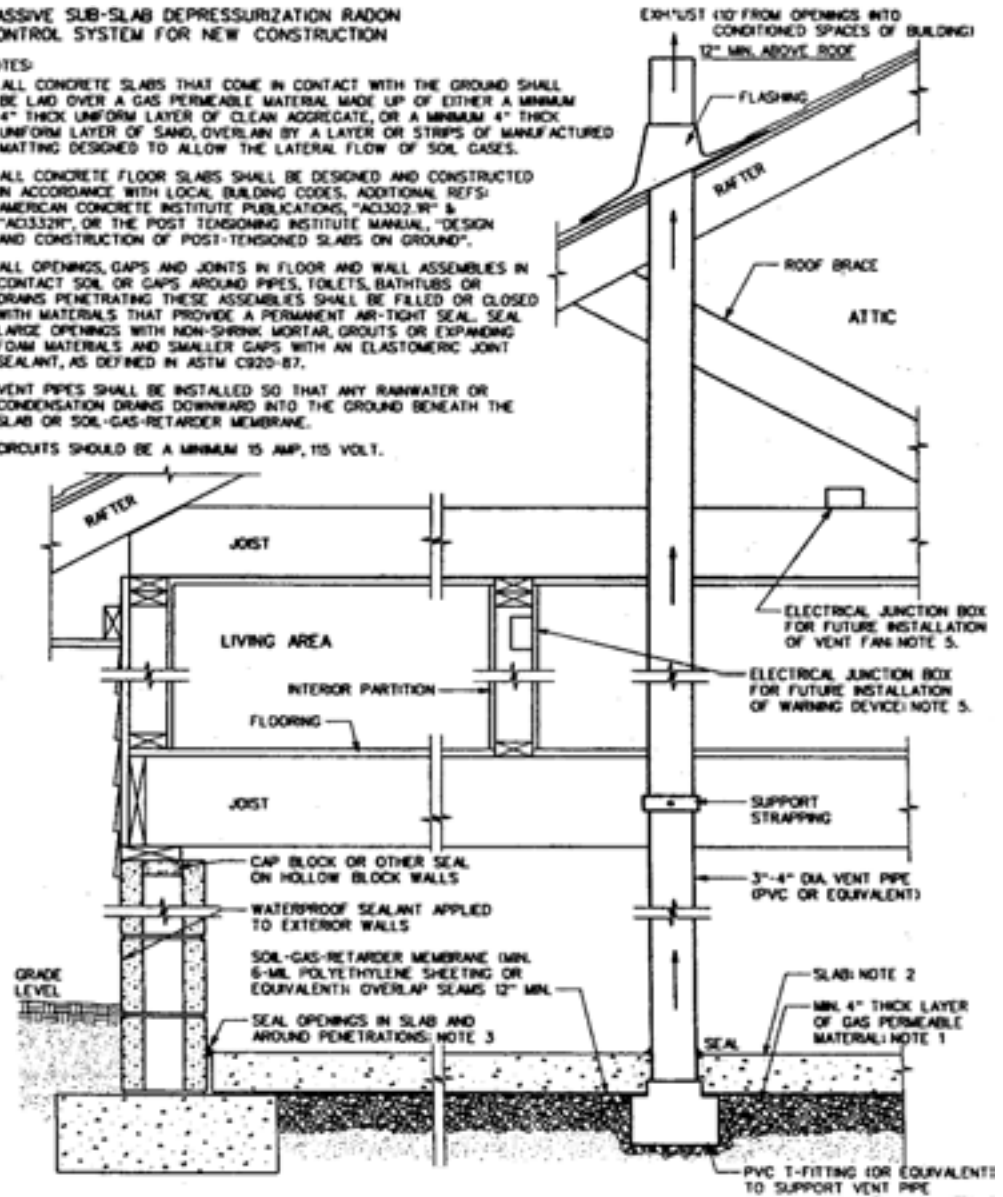

Architectural Drawing
 Passive Sub-Membrane
 Depressurization System
 Used for crawlspace construction

**PASSIVE RADON CONTROL SYSTEM IN
 CRAWL SPACE FOR NEW CONSTRUCTION**

NOTES:

1. INSTALL A LENGTH OF 3" OR 4" DIAMETER PERFORATED DRAIN TILE HORIZONTALLY BENEATH THE SHEETING AND CONNECT TO THE "T" FITTING WITH THE VERTICAL STANDPIPE THROUGH THE SOIL-GAS-RETARDER MEMBRANE. THIS HORIZONTAL PIPE SHOULD NORMALLY BE PLACED PARALLEL TO THE LONG DIMENSION OF THE HOUSE AND SHOULD EXTEND NO CLOSER THAN 6 FEET TO THE FOUNDATION WALL.
2. VENTILATE CRAWLSPACES IN CONFORMANCE WITH LOCAL CODES; VENTS SHALL BE OPEN TO THE EXTERIOR AND BE OF NONCLOSEABLE DESIGN.
3. CIRCUITS SHOULD BE A MINIMUM 15 AMP, 115 VOLT.

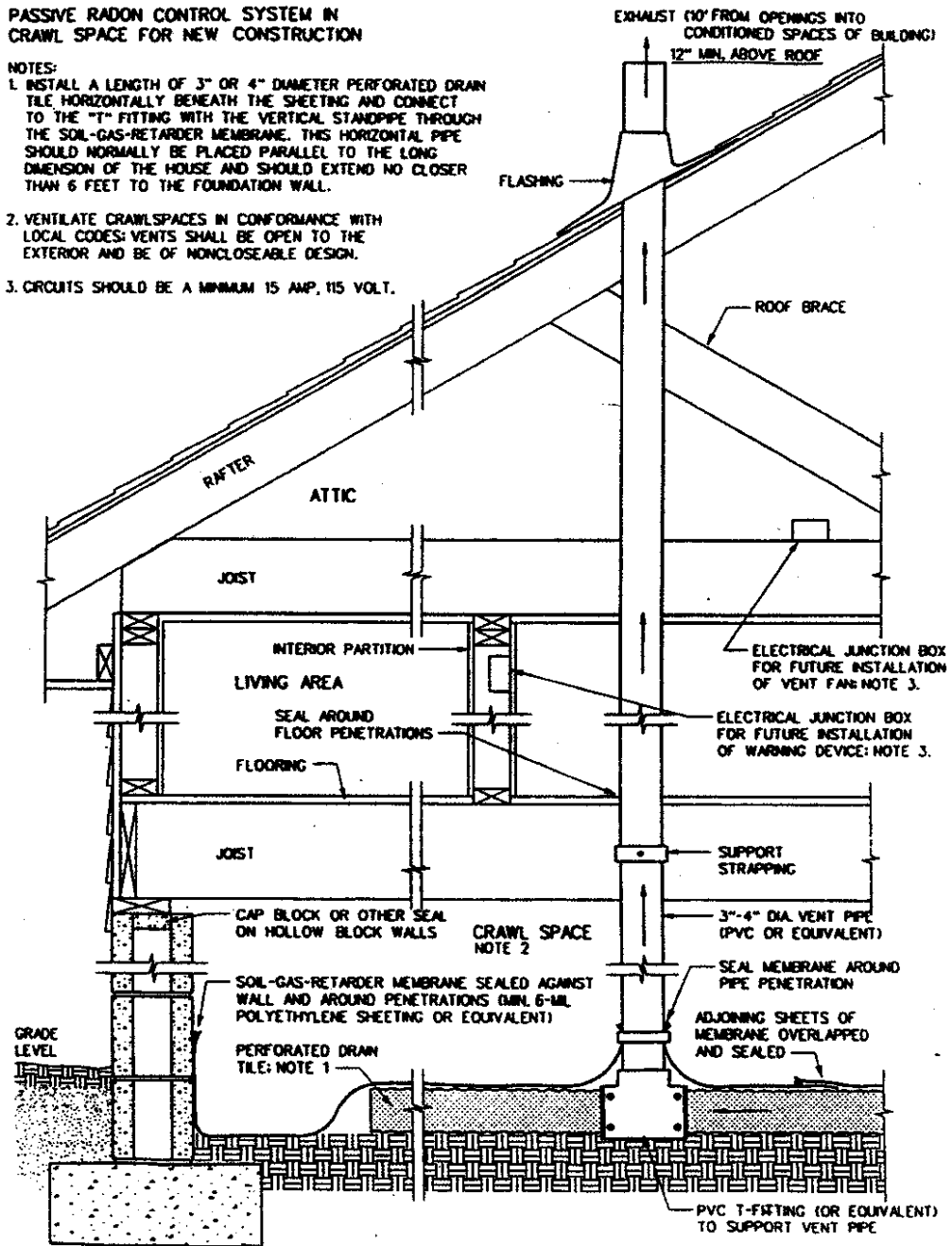

Architectural Drawing Active Sub-Slab Depressurization System

Uses fan to mechanically draw air from beneath the slab (or membrane) through the vent pipe.

ADDITIONAL COMPONENTS REQUIRED FOR ACTIVATION OF PASSIVE SUB-SLAB DEPRESSURIZATION OR CRAWLSPACE RADON CONTROL SYSTEM

NOTES:

1. INSTALL THE VENT FAN IN THE VERTICAL RUN OF THE VENT PIPE. THE SIZE AND AIR MOVEMENT CAPACITY OF THE VENT FAN SHALL BE SUFFICIENT TO CREATE AND MAINTAIN A PRESSURE FIELD BENEATH THE SLAB OR CRAWLSPACE MEMBRANE THAT IS LOWER THAN THE PRESSURE ABOVE THE SLAB OR MEMBRANE.
2. ALL POSITIVELY PRESSURED PORTIONS OF THE VENT PIPE AND FAN SHALL BE LOCATED OUTSIDE THE HABITABLE SPACE OF THE BUILDING.
3. PROVIDE A VISIBLE OR AUDIBLE WARNING SYSTEM TO ALERT THE BUILDING OCCUPANT IF THERE IS A LOSS OF PRESSURE OR AIR FLOW IN THE VENT PIPE.

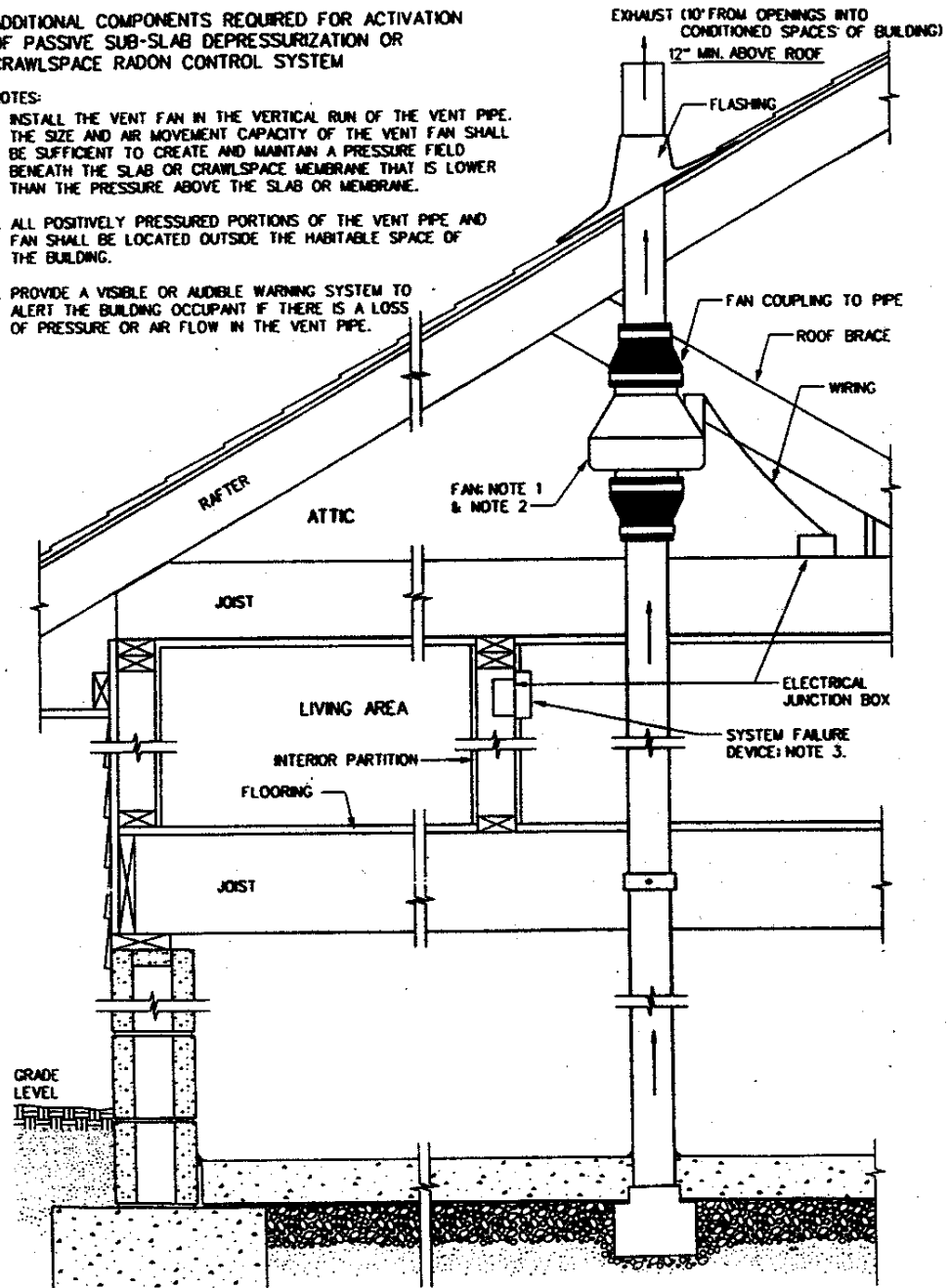

Glossary

Active System

Passive system with the addition of a fan to more actively draw radon from the soil into the stack where it dissipates into the atmosphere. A system-failure warning device (alarm) is also installed to alert the occupant if the system is not working.

Action level

Home owners should take action to lower radon levels indoors when levels are at or above 4 pCi/L.

Aggregate

A coarse material, such as gravel, placed below the slab.

ASTM Standard Guide 1465-92

A guidance booklet published in 1992 by the American Society for Testing and Materials according to their consensus process for deciding on the content.

Building Code

Criteria or requirements (i.e., minimum standards) set forth and enforced by a state or local agency for the protection of public health and safety. Is usually based on a model code (see below) and/or Model Standards published by acknowledged organizations or associations.

Condensation

Vapor in the air turns into water on cold surfaces. Beads or drops of water (and frost in extremely cold weather) accumulate on the inside of the exterior covering of a building when warm, moisture-laden air from the interior reaches a point where the temperature no longer permits the air to sustain the moisture it holds.

Condensate drains

Drains which remove condensation from air-conditioning or other equipment, frequently empty into the sump or below the slab.

Dampproofing

Sealing the foundation walls to prevent outside moisture from entering the basement, although not as tightly as in water-proofing.

Drain Tile Loop

Typically refers to a length of perforated pipe extending around all or part of the footing perimeter for draining water away from the foundation of a home.

Flashing

Material for reinforcing and weatherproofing the joints and angles of the roof and penetrations through the roof.

Footing

The supporting base for the foundation walls of a house.

Gas-permeable

A material through which gas passes easily.

International Codes

Model codes published by the International Code Council (ICC) to combine all four model building codes into one. The *International Residential Code* was published in early 2000.

Junction Box

An enclosed box used to connect or branch electrical wiring.

Map of Radon Zones

EPA's Map of Radon Zones assigns each of the 3141 counties in the United States to one of three zones based on radon potential:

Zone 1

Counties have a predicted average indoor screening level greater than 4 pCi/L

Zone 2

Counties have a predicted average indoor screening level between 2 and 4 pCi/L

Zone 3

Counties have a predicted average indoor screening level less than 2 pCi/L

Elevated radon have been found in all counties (Zone 1, Zone 2 and Zone 3).

Model Codes

Documents specifying requirements for building, mechanical, plumbing, and fire prevention installations. Often the basis for state and local building codes.

Model Standard

A document that has been developed and established to connote specified consensus and approval of certain techniques and standards. A prescribed level of acceptability or an approved model used as a basis for comparison. Voluntary technical guidance until adopted into a building code. EPA has published one for radon-resistant new construction, called *Model Standards and Techniques for Control of Radon in New Residential Buildings*.

Passive System

Short for passive sub-slab depressurization system. Features to reduce radon levels by utilizing barriers to radon entry and stack effect reduction techniques and the

installation of a PVC pipe running from beneath the slab to the roof. Works by using natural pressure differentials between the air in the pipe, and the rest of the home and the outside air.

Picocuries per liter (pCi/L)

A unit of measuring radon levels.

Polyethylene Sheeting (used as soil-gas-retarder)

Plastic sheeting, about drop cloth weight, used over gravel and under the concrete slab to prevent soil gases from entering a home. The sheeting also prevents the concrete from flowing into the gravel and blocking air flow beneath the slab. Also used as a moisture barrier.

PVC Pipe

A hollow plastic pipe generally used for plumbing in home construction.

Slab

The concrete “floor” poured over the ground between the foundation walls, either at ground floor or basement level.

Soil Gas

Any gas emanating from the soil, including radon, methane, and water vapor.

Stack Effect Reduction Techniques

Features that prevent or reduce the flow of warm conditioned air upward and out of the building superstructure. If not reduced, stack effect can actually draw soil gas containing radon into the lower levels of the house. Most of these techniques are part of the International Code Council’s *Model Energy Code*.

Sub-Membrane Depressurization

A system designed to achieve lower sub-membrane air pressure relative to crawlspace air pressure by use of a vent drawing air from beneath the soil-gas retarder membrane. May be a passive system (without fan) or active system (with fan).

Sub-Slab Depressurization

A system designed to achieve lower sub-slab air pressure relative to indoor air pressure. May be a passive system (no fan) or active system (with fan).

Sump / Sump pit

A hole going below the slab into which water is drained in order to be pumped out. Should be sealed to prevent radon from entering the home.

For More Information

Hotlines

National Safety Council

1-800-55-RADON

Answers consumers' specific questions dealing with radon

Consumer Federation of America

Foundation's Radon Fix-It Program

1-800-644-6999

Answers questions for consumers with high radon levels about how to fix the problem

IAQ Info

1-800-438-4318

Answers specific indoor air quality questions

Literature referrals

National Hispanic Indoor Air Quality Hotline

1-800-SALUD-12

Bilingual health information specialists provide answers about radon and provide test kits to consumers with bilingual instructions

EPA Website

Check out the Indoor Environments Division Home Page for information and online publications about radon and indoor air quality: www.epa.gov/iaq

Publications

Protecting Your Home from Radon

Second edition, 1997 (Kladder, D.L., Burkhart, J.F., Jelinek, S.R.). This document details many radon-resistant construction techniques, and includes many useful photos and illustrations. It is available in many public libraries or from the National Environmental Health Association at 1-800-513-8332 or www.neha.org.

Radon-Resistant Construction and Building Codes

This document provides general information on radon, and an explanation on each section in Appendix D of the 1998 International

One and Two Family Dwelling Code. To download the zipped PDF file visit the International Code Council website at www.intlcode.org/download/index.htm.

ASTM E1465-92 Standard Guide for Radon Control Options for the Design and Construction of New Low Rise Residential Buildings

This guide covers design and construction methods for reducing radon entry into new low-rise residential buildings and is intended to assist designers, builders, building officials and others involved in the construction of low-rise residential buildings. Available from the American Society for Testing and Materials. 100 Barr Harbor Drive, West Conshohocken, PA 19428-2959. 1-610-832-9585 or www.astm.org

EPA Publications

Order copies in singles or in bulk from the National Service Center for Environmental Publications (NSCEP) 1-800-490-9198 or www.epa.gov/ncepihome/index.html

Sample of available publications:

Building A New Home: Have You Considered Radon?

EPA/402-F-98-001

Colorful brochure on the basics of radon-resistant features.

Buying A New Home? How To Protect Your Family From Radon

EPA/402-F-98-008

This brochure provides a quick summary and diagram of the major components of the radon reduction system. Great for educating homebuyers about radon.

Model Standards and Techniques for Control of Radon in New Residential Buildings

EPA/402-R-94-009

EPA Map of Radon Zones (color)

EPA/402-F-93-013

Radon Doesn't Have to be a Problem

EPA/402-V-95-015

12-minute video by the National Association of Home Builders (NAHB) explaining radon-resistant features.

Radon Resistant New Homes: A Public Official's Guide to Reducing Radon Risk

EPA/402-V-95-014

Short video by the National Conference of States on Building Codes and Standards (NCSBCS) on radon-resistant features.

Other Sources of Information

International Code Council (ICC)

5203 Leesburg Pike, Suite 708
Falls Church, VA 22041

(703) 931-4533

(703) 379-1546 fax

www.intlcode.org

ICC publishes model codes, including the *International Residential Code (IRC)*. The IRC contains an Appendix on radon-resistant construction. They also publish a separate guide to radon-resistant construction.

State Radon Contacts

For a complete, up-to-date listing, check the web page: www.epa.gov/iaq/radon/contacts.html.

Alabama	(800) 582-1866	New Hampshire	(800) 852-3345 x4674
Alaska	(800) 478-8324	New Jersey	(800) 648-0394
Arizona	(602) 255-4845 x244	New Mexico	(505) 476-8531
Arkansas	(800) 482-5400	New York	(800) 458-1158
California	(800) 745-7236	North Carolina	(919) 571-4141
Colorado	(800) 846-3986	North Dakota	(800) 252-6325
Connecticut	(860) 509-7367	Ohio	(800) 523-4439
Delaware	(800) 464-4357	Oklahoma	(405) 702-5100
District of Columbia	(202) 535-2999	Oregon	(503) 731-4014 x664
Florida	(800) 543-8279	Pennsylvania	(800) 237-2366
Georgia	(800) 745-0037	Puerto Rico	(787) 274-7815
Guam	(671) 475-1611	Rhode Island	(401) 222-2438
Hawaii	(808) 586-4700	South Carolina	(800) 768-0362
Idaho	(800) 445-8647	South Dakota	(800) 438-3367
Illinois	(800) 325-1245	Tennessee	(800) 232-1139
Indiana	(800) 272-9723	Texas	(800) 572-5548
Iowa	(800) 383-5992	Utah	(800) 458-0145
Kansas	(800) 693-5343	Vermont	(800) 439-8550
Kentucky	(502) 564-4856	Virgin Islands	(212) 637-4013
Louisiana	(800) 256-2494	Virginia	(800) 468-0138
Maine	(800) 232-0842	Washington	(360) 236-3253
Maryland	(800) 438-2472 x2086	West Virginia	(800) 922-1255
Massachusetts	(800) RADON95	Wisconsin	(888) 569-7236
Michigan	(800) 723-6642	Wyoming	(800) 458-5847
Minnesota	(800) 798-9050		
Mississippi	(800) 626-7739	<i>Tribal Radon Program Offices</i>	
Missouri	(800) 669-7236	Hopi Tribe (Arizona)	(520) 734-2442 x635
Montana	(800) 546-0483	Inter-Tribal Council of Arizona	(602) 307-1527
Nebraska	(800) 334-9491	Navajo Nation	(520) 871-7863
Nevada	(775) 687-5394 x275	Duckwater Shoshone-Paiute Tribe	(702) 863-0222 (Nevada)

Note

As of 9/30/98, EPA no longer runs a National Radon Proficiency Program. Some states “regulate” providers of radon measurement and mitigation service providers and measurement devices by requiring registration, certification, or licensing. Some of these states issue identification cards. Call your state to learn more. You can also contact the National Environmental Health Association’s (NEHA) National Radon Proficiency Program at 1-800-269-4174 (radonprog@aol.com) or, the National Radon Safety Board (NRSB) at (303) 423-2674 (info@nrsb.org) for more information on radon proficiency.

Building Radon Out

This toolkit is designed to:

- ✓ Answer your questions about radon and radon-resistant features in new homes
- ✓ Give you step-by-step guidelines and tips on how to install radon-resistant features
- ✓ Provide practical ideas on educating potential home buyers about the features

